

# Precision Laboratory & Ground Joint Thermometers & Sets

## High-precision temperature measuring instruments

Precision laboratory thermometers,  
Precision laboratory thermometer sets,  
Ground joint thermometers, Accessories

Catalogue 3/4



Ludwig Schneider 

High-precision measuring instruments for  
temperature and density

# DAkks calibration laboratory for temperature and density

Ludwig Schneider is one of the world's leading manufacturers of precision measuring instruments for temperature and density. Based on these experiences its subsidiary company Ludwig Schneider Messtechnik GmbH (LSM) has been offering calibration services for temperature measurements for more than 20 years.

Since 2005 LSM has been the first private-sector company in Germany with accreditation for density measurements of hydrometers.

International customers of the chemical, pharmaceutical, mineral oil/refinery, food processing industries and oceanography are using the LSM calibration services

## DAkks accreditation

Ludwig Schneider Messtechnik is accredited under registration number D-K-15223-01-00 by the Accreditation Body „Deutsche Akkreditierungsstelle“ and fully complies with the requirements of DIN EN ISO/IEC 17025.

United under the International Laboratory Accreditation Cooperation (ILAC), 52 nations at present have contractually agreed to mutually accept the calibration results of the signatories' accredited calibration laboratories according to DIN EN ISO/IEC 17025.

## Our range of services

- Comparative measurements of resistance thermometers, thermocouples, liquid-in-glass thermometers, temperature indicators, temperature block calibrators
- Adjustment of digital/analog measured data acquisition systems
- Calculation of specific constants on the basis of ITS-90 deviation functions, Van Dusen equations, polynomial functions
- Documentation of calibration results: DKD/DAkks calibration certificates, manufacturers' test certificates, conformity statements, compliance with QM codes and standards (DIN, ASTM, BS, IEC, etc.)

ISO  
ASTM  
BS  
DIN



Deutsche  
Akkreditierungsstelle  
D-K-15223-01-00



## Ludwig Schneider Messtechnik GmbH

Postfach 1561 · 97865 Wertheim  
Am Eichamt 4 · 97877 Wertheim  
Tel.: +49-93 42-85 60-0  
Fax: +49-93 42-8 43 99  
Mail: dakks@ludwig-schneider.de  
www.dakks-lsm.de

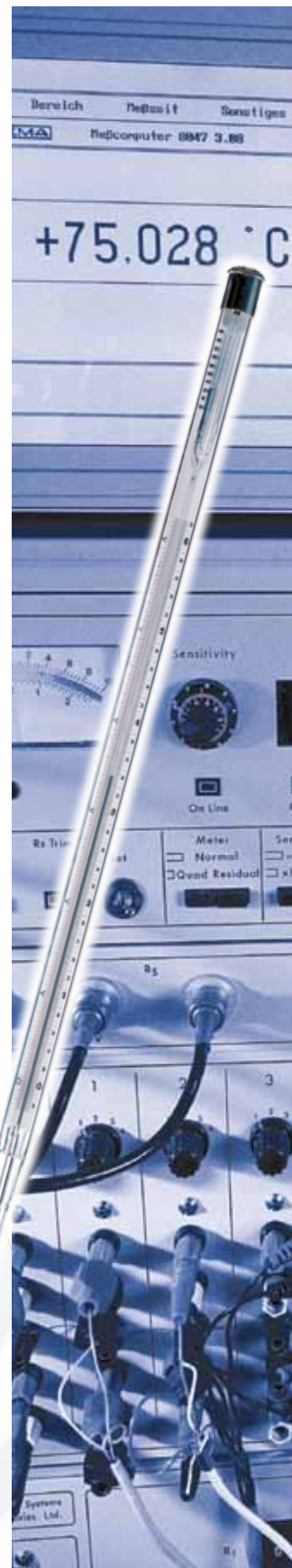

# Contents

<b>Precision faden thermometers</b>	<b>4</b>
<b>Precision laboratory thermometers</b> acc. to DIN 12775 & 12778	<b>5</b>
<b>Precision low-temperature thermometers</b>	<b>6</b>
<b>Precision laboratory thermometers</b> enclosed type	<b>7</b>
<b>Precision laboratory thermometers</b> solid stem type	<b>8</b>
<b>Precision high-temperature laboratory thermometers</b>	<b>9</b>
<b>Universal precision thermometer sets</b>	<b>10</b>
<b>Precision thermometer sets</b> acc. to Landsberger	<b>11</b>
<b>Precision thermometer sets</b> acc. to Anschütz	<b>12-13</b>
<b>Precision thermometer sets</b> acc. to Kahlbaum	<b>14</b>
<b>Metal protection cases for laboratory thermometers</b>	<b>15</b>
<b>Ice point and boiling point precision thermometers</b>	<b>16</b>
<b>High-precision standard thermometers</b>	<b>17</b>
<b>High-precision standard thermometer sets</b>	<b>18-19</b>
<b>Precision laboratory straight stem thermometers</b>	<b>20-23</b>
<b>Precision calorimeter thermometers</b> acc. to DIN 12771	<b>24</b>
<b>Precision calorimeter thermometers</b> with auxiliary scale	<b>25</b>
<b>Precision calorimeter thermometers</b> acc. to Berthelot-Mahler	<b>26</b>
<b>Precision calorimeter thermometers</b> acc. to ISO 651/BS 791	<b>27</b>
<b>Precision adjusting thermometers</b> acc. to Beckmann	<b>28</b>
<b>Magnifying glasses for high-precision thermometers</b>	<b>29</b>
<b>Remote monitoring system OPTI-MESS 2000</b>	<b>29</b>
<b>Precision ground joint thermometers</b>	<b>30-33</b>
<b>Thermometers for Pyknometers</b> acc. to DIN 12809	<b>34</b>
<b>Precision thermometers for adjustable ground joints</b>	<b>35</b>
<b>Adjustable ground joints</b>	<b>35</b>
<b>Technical information</b>	<b>36-38</b>

# Precision faden thermometers

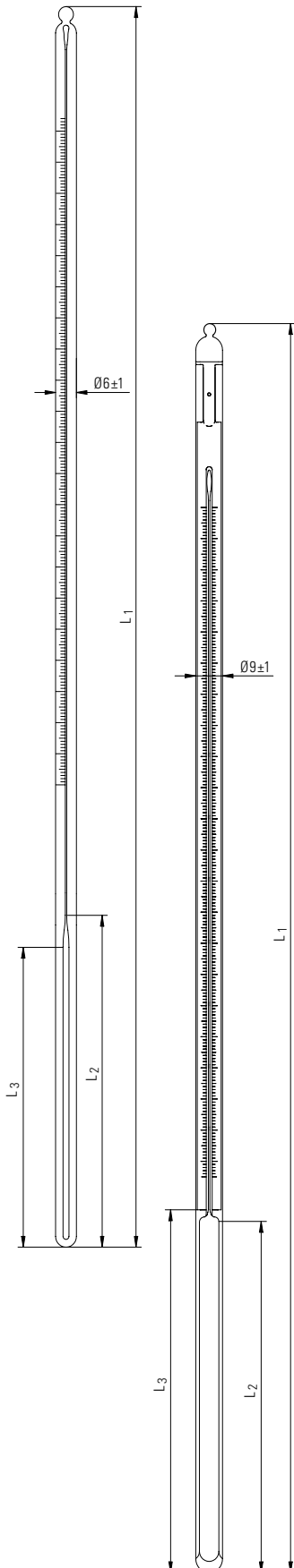

## Precision faden thermometers

For the measurement of the medium column temperature (MCT)

### Stem type

Ø 6 ± 1 mm, filling: Hg, suitable for official certification

Temperature range °C	Scale °C	Capillary form	Bulb length L <sub>3</sub> mm	Immersion L <sub>2</sub> mm	Total length L <sub>1</sub> mm	Ref. No.
0 +100	1	yellow back, round	100	105	300	1032001
0 +150	1	yellow back, round	100	105	340	1032002
0 +250	1	yellow back, round	100	105	360	1032003
0 +360	1	yellow back, round	100	105	400	1032004
0 +524	2	yellow back, prismatic	100	105	400	1032005
0 +624	2	yellow back, prismatic	100	105	400	1032006
0 +100	1	yellow back, round	150	155	350	1032007
0 +150	1	yellow back, round	150	155	390	1032008
0 +250	1	yellow back, round	150	155	410	1032009
0 +360	1	yellow back, round	150	155	450	1032010
0 +524	2	yellow back, prismatic	150	155	450	1032011
0 +624	2	yellow back, prismatic	150	155	450	1032012
0 +100	1	yellow back, round	200	205	400	1032013
0 +150	1	yellow back, round	200	205	440	1032014
0 +250	1	yellow back, round	200	205	460	1032015
0 +360	1	yellow back, round	200	205	500	1032016
0 +524	2	yellow back, prismatic	200	205	500	1032017
0 +624	2	yellow back, prismatic	200	205	500	1032018

## Precision faden thermometers

For the measurement of the medium column temperature (MCT)

### Enclosed type

Ø 9 ± 1 mm, filling: Hg, suitable for official certification

Temperature range °C	Scale °C	Capillary form	Bulb length L <sub>3</sub> mm	Immersion L <sub>2</sub> mm	Total length L <sub>1</sub> mm	Ref. No.
0 +100	1	colourless, prismatic	100	105	300	1032101
0 +150	1	colourless, prismatic	100	105	340	1032102
0 +250	1	colourless, prismatic	100	105	360	1032103
0 +360	1	colourless, prismatic	100	105	400	1032104
0 +524	2	colourless, prismatic	100	105	400	1032105
0 +624	2	colourless, prismatic	100	105	400	1032106

### Additional Order No.

- ...../01 Officially calibrated without certificate
- ...../02 Officially calibrated with certificate
- ...../03 With works certificate
- ...../04 With DAkkS calibration certificate

# Precision laboratory thermometers acc. to DIN 12775 and 12778

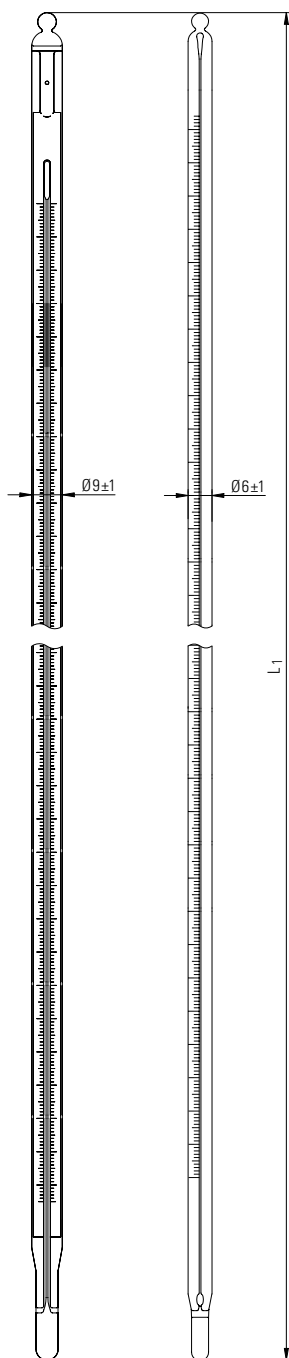

Precision laboratory thermometers

**acc. to DIN 12775, enclosed type**

Ø 9 ±1 mm, immersion: total, suitable for official certification

Temperature range °C	Scale °C	Filling	Capillary form	Total length L <sub>1</sub> mm	Ref. No.
-30 +50	0.5	Hg	colourless, prismatic	220	1032201
0 +50	0.5	Hg	colourless, prismatic	220	1032202
0 +100	0.5	Hg	colourless, prismatic	270	1032203
0 +150	0.5	Hg	colourless, prismatic	350	1032204
0 +200	0.5	Hg	colourless, prismatic	400	1032205
0 +250	0.5	Hg	colourless, prismatic	420	1032206
0 +360	0.5	Hg	colourless, prismatic	480	1032207
0 +50	0.2	Hg	colourless, prismatic	350	1032208
0 +100	0.2	Hg	colourless, prismatic	420	1032209
0 +50	0.1	Hg	colourless, prismatic	420	1032210
+50 +100	0.1 *	Hg	colourless, round	480	1032211

\* with auxiliary scale at 0 °C

Precision laboratory thermometers

**acc. to DIN 12778, enclosed type**

Ø 9 ±1 mm, immersion: total, suitable for official certification

Temperature range °C	Scale °C	Filling	Capillary form	Total length L <sub>1</sub> mm	Ref. No.
-200 +30	1	Pentane	blue reflecting, prismatic	350	1032301
-100 +30	1	Alcohol	colourless, prismatic	305	1032302
-50 +50	1	Toluol	colourless, prismatic	305	1032303
0 +100	1	Hg	colourless, prismatic	305	1032304
0 +150	1	Hg	colourless, prismatic	305	1032305
0 +250	1	Hg	colourless, prismatic	350	1032306
0 +360	1	Hg	colourless, prismatic	380	1032307

Precision laboratory thermometers

**acc. to DIN 12778, stem type**

Ø 6 ±1 mm, immersion: total, suitable for official certification

Temperature range °C	Scale °C	Filling	Capillary form	Total length L <sub>1</sub> mm	Ref. No.
<del>-200 +30</del>	<del>1</del>	<del>Pentane</del>	<del>blue reflecting, prismatic</del>	<del>350</del>	<del>1032401</del>
-100 +30	1	Alcohol	white back, round	305	1032402
-50 +50	1	Toluol	white back, round	305	1032403
0 +100	1	Hg	white back, round	305	1032404
0 +150	1	Hg	white back, round	305	1032405
0 +250	1	Hg	white back, round	350	1032406
0 +360	1	Hg	white back, round	380	1032407
0 +480	2	Hg	yellow back, prismatic	450	1032408
0 +610	2	Hg	yellow back, prismatic	450	1032409

## Additional Order No.

- ...../01 Officially calibrated without certificate
- ...../02 Officially calibr. with cert.
- ...../03 With works certificate
- ...../04 With DAkkS calibration cert.
- ...../50 Capillary: blue refl., prism.
- ...../80 "Safety coating"  
(PTFE coated up to 200 °C)

Metal protection cases for these thermometers you can find on page 15.

# Precision low-temperature laboratory thermometers

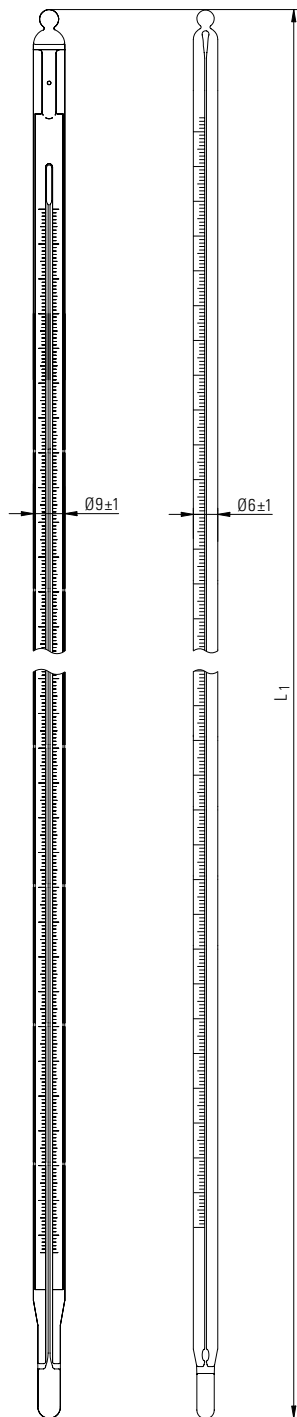

Precision low-temperature laboratory thermometers

## Enclosed type

Ø 9 ±1 mm, immersion: total, suitable for official certification

Temperature range °C	Scale °C	Filling	Capillary form	Total length L <sub>1</sub> mm	Ref. No.
-150 +30	1	Pentane	blue reflecting prismatic	300	1042402
-100 +100	1	Alcohol	colourless, prismatic	300	1042403
-80 +30	1	Toluol	colourless, prismatic	300	1042405
-38 +50	1	Hg	colourless, prismatic	280	1042407
-50 +30	1	Toluol	colourless, prismatic	280	1042409
-50 +50	0.5	Toluol	colourless, prismatic	300	1042504
-38 +50	0.5	Hg	colourless, prismatic	300	1042505
-50 +50	0.2	Toluol	colourless, prismatic	420	1042602 *
-38 +50	0.2	Hg	colourless, prismatic	400	1042604
-50 +50	0.1	Toluol	colourless, prismatic	580	1042701 *
-58 +30	0.1	Hg-Tl	colourless, prismatic	550	1042702
-38 +50	0.1	Hg	colourless, prismatic	550	1042703
-30 +30	0.1	Hg	colourless, prismatic	400	1042704

\* no official certification possible

Precision low-temperature laboratory thermometers

## Stem type

Ø 6 ±1 mm, immersion: total, suitable for official certification

Temperature range °C	Scale °C	Filling	Capillary form	Total length L <sub>1</sub> mm	Ref. No.
-100 +100	1	Alcohol	yellow back, round	300	1052003
-100 +30	1	Alcohol	yellow back, round	300	1052004
-80 +30	1	Toluol	yellow back, round	300	1052005
-50 +50	1	Toluol	yellow back, round	280	1052006
-38 +50	1	Hg	yellow back, round	280	1052007
-50 +30	1	Toluol	yellow back, round	280	1052009
-50 +50	0.5	Toluol	yellow back, round	300	1052104
-38 +50	0.5	Hg	yellow back, round	300	1052105
-38 +50	0.1	Hg	yellow back, round	550	1052303
-30 +30	0.1	Hg	yellow back, round	400	1052304

Metal protection cases for these thermometers you can find on page 15.

## Additional Order No.

- ...../01 Officially calibrated without certificate
- ...../02 Officially calibrated with certificate
- ...../03 With works certificate
- ...../04 With DAkkS calibration certificate
- ...../50 Capillary: blue reflecting, prismatic
- ...../80 "Safety coating" (PTFE coated up to 200 °C)

# Precision laboratory thermometers

## Enclosed type

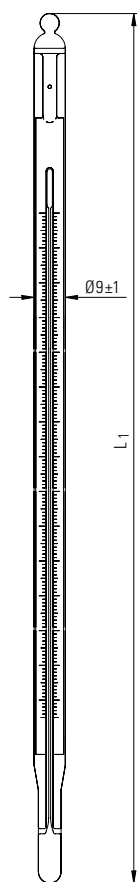

Precision laboratory thermometers

### Enclosed type

Ø 9 ±1 mm, immersion: total, suitable for official certification

Temperature range °C	Scale °C	Filling	Capillary form	Total length L <sub>1</sub> mm	Ref. No.
-10 +50	1	Hg	colourless, prismatic	250	1032501
-10 +100	1	Hg	colourless, prismatic	280	1032502
-10 +150	1	Hg	colourless, prismatic	300	1032503
-10 +200	1	Hg	colourless, prismatic	300	1032504
-10 +250	1	Hg	colourless, prismatic	320	1032505
-10 +300	1	Hg	colourless, prismatic	320	1032506
-10 +410	1	Hg	colourless, prismatic	380	1032508
-10 +50	0.5	Hg	colourless, prismatic	280	1032601
-10 +100	0.5	Hg	colourless, prismatic	300	1032602
-10 +150	0.5	Hg	colourless, prismatic	350	1032603
-10 +200	0.5	Hg	colourless, prismatic	380	1032604
-5 +50	0.2	Hg	colourless, prismatic	350	1032701
-5 +100	0.2	Hg	colourless, prismatic	400	1032703
-5 +150	0.2	Hg	colourless, prismatic	480	1032705
-5 +200	0.2	Hg	colourless, prismatic	550	1032706
-10 +30	0.1	Hg	colourless, prismatic	300	1032801
0 +50	0.1	Hg	colourless, prismatic	400	1032802
-10 +50	0.1	Hg	colourless, prismatic	400	1032803
-20 +50	0.1	Hg	colourless, prismatic	450	1032804
0 +100	0.1	Hg	colourless, prismatic	550	1032805
-10 +100	0.1	Hg	colourless, prismatic	580	1032806
+50 +150	0.1	Hg	colourless, prismatic	550	1032807*
+100 +200	0.1	Hg	colourless, prismatic	550	1032808*
-10 +100	1	red	colourless, prismatic	305	1042341
-10 +150	1	red	colourless, prismatic	305	1042342
-10 +200	1	red	colourless, prismatic	350	1042350
-10 +50	0.5	red	colourless, prismatic	220	1042343
-10 +100	0.5	red	colourless, prismatic	270	1042344
-10 +150	0.5	red	colourless, prismatic	350	1042345*
-10 +200	0.5	red	colourless, prismatic	450	1042351*
-5 +50	0.2	red	colourless, prismatic	350	1042346*
-5 +100	0.2	red	colourless, prismatic	420	1042347*
-10 +30	0.1	red	colourless, prismatic	300	1042353*
0 +50	0.1	red	colourless, prismatic	420	1042348*
-10 +50	0.1	red	colourless, prismatic	420	1042349*
0 +100	0.1	red	colourless, prismatic	550	1042354*

\* no official certification possible

### Additional Order No.

- ...../01 Officially calibrated  
without certificate
- ...../02 Officially calibrated  
with certificate
- ...../03 With works certificate
- ...../04 With DAkkS calibration  
certificate
- ...../50 Capillary: blue reflecting,  
prismatic
- ...../80 "Safety coating"  
(PTFE coated up to 200 °C)

Metal protection cases for these thermometers you can find on page 15.

# Precision laboratory thermometers

## Stem type

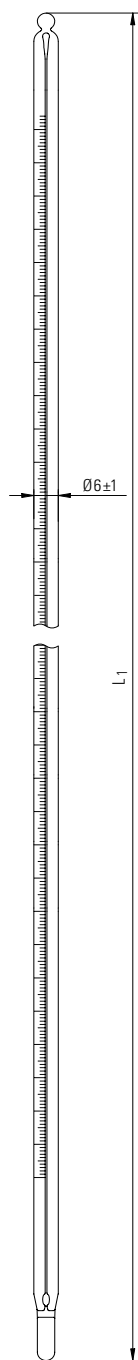

Precision laboratory thermometers

### Stem type

Ø 6 ±1 mm, immersion: total, suitable for official certification

Temperature range °C	Scale °C	Filling	Capillary form	Total length L <sub>1</sub> mm	Ref. No.
-10 +50	1	Hg	yellow back, round	250	1042001
-10 +100	1	Hg	yellow back, round	280	1042002
-10 +150	1	Hg	yellow back, round	300	1042003
-10 +250	1	Hg	yellow back, round	320	1042005
-10 +300	1	Hg	yellow back, round	320	1042006
-10 +410	1	Hg	yellow back, round	380	1042008
-10 +50	0.5	Hg	yellow back, round	280	1042101
-10 +100	0.5	Hg	yellow back, round	300	1042102
-10 +150	0.5	Hg	yellow back, round	350	1042103
-10 +200	0.5	Hg	yellow back, round	380	1042104
-5 +50	0.2	Hg	yellow back, round	350	1042201
-5 +100	0.2	Hg	yellow back, round	400	1042203
-5 +150	0.2	Hg	yellow back, round	480	1042205
-10 +30	0.1	Hg	yellow back, round	300	1042301
0 +50	0.1	Hg	yellow back, round	400	1042302
-10 +50	0.1	Hg	yellow back, round	400	1042303
0 +100	0.1	Hg	yellow back, round	550	1042305
-10 +100	0.1	Hg	yellow back, round	580	1042306
+50 +150	0.1	Hg	yellow back, round	550	1042307*
-10 +100	1	red	yellow back, round	305	1042371
-10 +150	1	red	yellow back, round	305	1042372
-10 +200	1	red	yellow back, round	350	1042381
-10 +50	0.5	red	yellow back, round	220	1042373
-10 +100	0.5	red	yellow back, round	270	1042374
-10 +150	0.5	red	yellow back, round	350	1042375*
-1 +201	0.5	red	yellow back, round	460	1042380*
-5 +50	0.2	red	yellow back, round	350	1042376*
-5 +100	0.2	red	yellow back, round	420	1042377*
-1 +200	0.2	red	yellow back, round	610	1042382*
-10 +30	0.1	red	yellow back, round	300	1042384*
0 +50	0.1	red	yellow back, round	420	1042378*
-10 +50	0.1	red	yellow back, round	420	1042379*
-1 +101	0.1	red	yellow back, round	610	1042383*

\* no official certification possible

Metal protection cases for these thermometers you can find on page 15.

### Additional Order No.

- ...../01 Officially calibrated without certificate
- ...../02 Officially calibr. with cert.
- ...../03 With works certificate
- ...../04 With DAkkS calibration cert.
- ...../50 Capillary: blue refl., prism.
- ...../80 „Safety coating“  
(PTFE coated up to 200 °C)



# Precision high-temperature laboratory thermometers

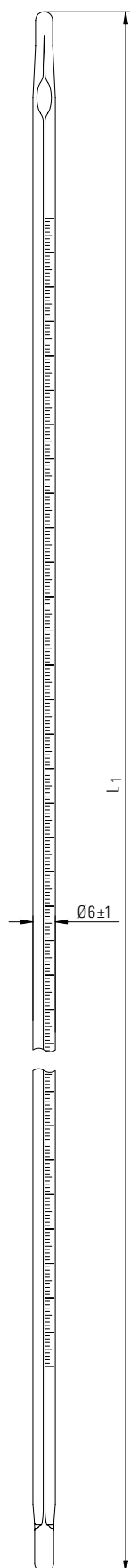

Precision high-temperature laboratory thermometers

## Stem type

Ø 6 ±1 mm, immersion: total, suitable for official certification

Temperature range °C	Scale °C	Filling	Capillary form	Total length L <sub>1</sub> mm	Ref. No.
-10 +525	1	Hg	yellow back, prismatic	450	1052501
-10 +625	1	Hg	yellow back, prismatic	450	1052504
-10 +630	2	Hg	yellow back, prismatic	450	1052507

## Additional Order No.

- ...../01 Officially calibrated without certificate
- ...../02 Officially calibrated with certificate
- ...../03 With works certificate
- ...../04 With DAkkS calibration certificate

# Universal precision thermometer sets

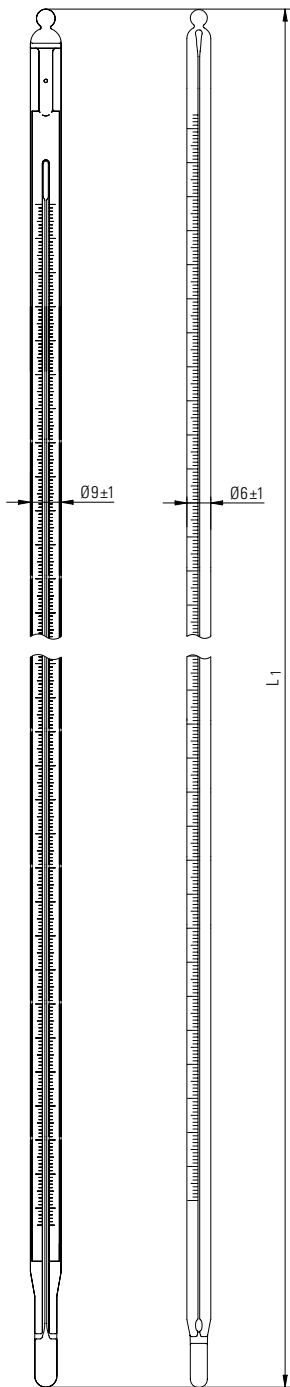

## Additional Order No.

- ...../01 Officially calibrated without certificate
- ...../02 Officially calibr. with cert.
- ...../03 With works certificate
- ...../04 With DAkkS calibration cert.
- ...../50 Capillary: blue refl., prism.
- ...../80 "Safety coating"  
(PTFE coated up to 200 °C)

## Universal precision thermometer set

Consisting of 14 instruments from -200 up to +1000 °C

### Enclosed type

Ø 9 ±1 mm, immersion: total, suitable for official certification

Temperature range °C	Scale °C	Filling	Capillary form	Total length L <sub>1</sub> mm	Ref. No.
-200 +30	0.5	Pentane	blue reflecting, prismatic	400	1122901*
-100 +30	0.5	Alcohol	colourless, prismatic	400	1122902
-58 +10	0.1	Hg-Tl	colourless, prismatic	400	1122903
0 +51	0.1	Hg	colourless, prismatic	400	1122904
+47 +101	0.1	Hg	colourless, prismatic	400	1122905
+97 +151	0.1	Hg	colourless, prismatic	400	1122906*
+147 +201	0.1	Hg	colourless, prismatic	400	1122907*
+197 +251	0.1	Hg	colourless, prismatic	400	1122908*
+247 +301	0.1	Hg	colourless, prismatic	400	1122909*
+297 +360	0.1	Hg	colourless, prismatic	400	1122910*
+350 +401	0.1	Hg	colourless, prismatic	400	1122911*
+395 +610	0.5	Hg	colourless, prismatic	400	1122912*
+300 +700	2	Hg	colourless, prismatic	400	1122913*
+500 +1000	5	Gallium	colourless, prismatic	400	1122914*
Complete set					1122915*
Complete set with case					1122916*
Case for 14 instruments					201101

\* no official certification possible

## Universal precision thermometer set

Consisting of 12 instruments from -200 up to +610 °C

### Stem type

Ø 6 ±1 mm, immersion: total, suitable for official certification

Temperature range °C	Scale °C	Filling	Capillary form	Total length L <sub>1</sub> mm	Ref. No.
-200 +30	0.5	Pentane	blue reflecting, prismatic	400	1132001*
-100 +30	0.5	Alcohol	yellow back, round	400	1132002
-58 +10	0.1	Hg-Tl	yellow back, round	400	1132003
0 +51	0.1	Hg	yellow back, round	400	1132004
+47 +101	0.1	Hg	yellow back, round	400	1132005
+97 +151	0.1	Hg	yellow back, round	400	1132006*
+147 +201	0.1	Hg	yellow back, round	400	1132007*
+197 +251	0.1	Hg	yellow back, round	400	1132008*
+247 +301	0.1	Hg	yellow back, round	400	1132009*
+297 +360	0.1	Hg	yellow back, round	400	1132010*
+350 +401	0.1	Hg	yellow back, round	400	1132011*
+395 +610	0.5	Hg	yellow back, prismatic	400	1132012*
Complete set					1132013*
Complete set with case					1132014*
Case for 12 instruments					201001

\* no official certification possible

# Precision thermometer sets acc. to Landsberger

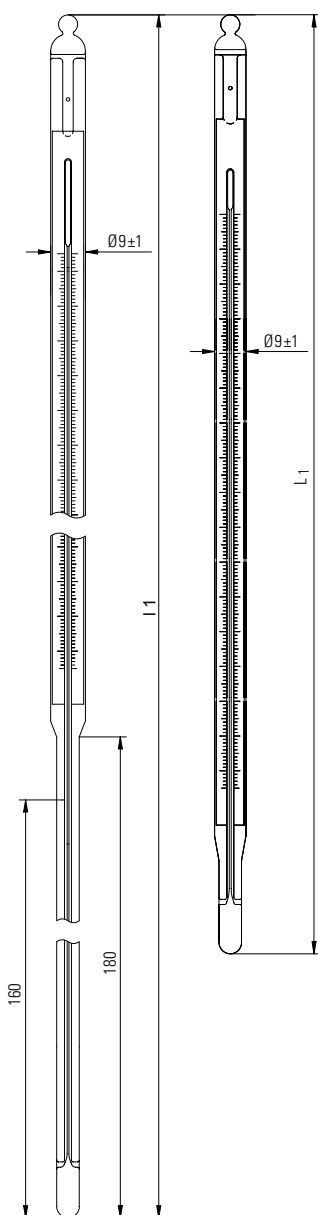

Precision thermometer set acc. to Landsberger  
Consisting of 6 instruments from -1 up to +102 °C

### Enclosed type

Ø 9 ±1 mm, **immersion: total**, suitable for official certification

Temperature range °C	Scale °C	Filling	Capillary form	Total length L <sub>1</sub> mm	Ref. No.
-1 +18	0.05	Hg	colourless, prismatic	300	1122401
+17 +35	0.05	Hg	colourless, prismatic	300	1122402
+34 +52	0.05	Hg	colourless, prismatic	300	1122403
+51 +68	0.05	Hg	colourless, prismatic	300	1122404
+67 +85	0.05	Hg	colourless, prismatic	300	1122405
+84 +102	0.05	Hg	colourless, prismatic	300	1122406
Complete set					1122407
Complete set with case					1122408
Case for 6 instruments					201801

Precision thermometer set acc. to Landsberger  
Consisting of 6 instruments from -1 up to +102 °C

### Enclosed type

Upper part Ø 9 ±1 mm, lower part Ø 6 mm (length: 180 mm),

**immersion: 160 mm**, suitable for official certification

Temperature range °C	Scale °C	Filling	Capillary form	Total length L <sub>1</sub> mm	Ref. No.
-1 +18	0.05	Hg	colourless, prismatic	480	1122501
+17 +35	0.05	Hg	colourless, prismatic	480	1122502
+34 +52	0.05	Hg	colourless, prismatic	480	1122503
+51 +68	0.05	Hg	colourless, prismatic	480	1122504
+67 +85	0.05	Hg	colourless, prismatic	480	1122505
+84 +102	0.05	Hg	colourless, prismatic	480	1122506
Complete set					1122507
Complete set with case					1122508
Case for 6 instruments					201701

### Additional Order No.

- ...../01 Officially calibrated without certificate
- ...../02 Officially calibrated with certificate
- ...../03 With works certificate
- ...../04 With DAkkS calibration certificate
- ...../50 Capillary: blue reflecting, prismatic
- ...../80 "Safety coating" (PTFE coated up to 200 °C)

# Precision thermometer sets acc. to Anschütz

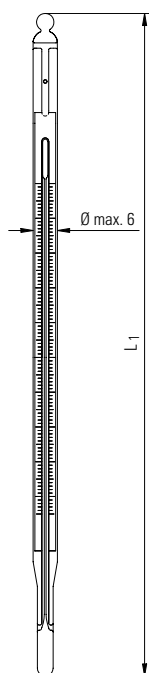

Precision thermometer set acc. to Anschütz

## acc. to DIN 12777

Consisting of 7 instruments from 0 up to +360 °C

### Enclosed type

Ø max. 6 mm, immersion: total, suitable for official certification

Temperature range °C	Scale °C	Filling	Capillary form	Total length L <sub>1</sub> mm	Ref. No.
0 +50	0.2	Hg	colourless, prismatic	175	1112801
+50 +100	0.2	Hg	colourless, prismatic	175	1112802
+100 +150	0.2	Hg	colourless, prismatic	175	1112803
+150 +200	0.2	Hg	colourless, prismatic	175	1112804
+200 +250	0.5	Hg	colourless, prismatic	175	1112805
+250 +300	0.5	Hg	colourless, prismatic	175	1112806
+300 +360	1	Hg	colourless, prismatic	175	1112807
Complete set					1112808
Complete set with case					1112809
Case for 7 instruments					202401

Precision thermometer set acc. to Anschütz

Consisting of 7 instruments from -10 up to +360 °C

### Enclosed type

#### Scale units: 0.2 °C

Ø max. 6 mm, immersion: total, suitable for official certification

Temperature range °C	Scale °C	Filling	Capillary form	Total length L <sub>1</sub> mm	Ref. No.
-10 +52	0.2	Hg	colourless, prismatic	190	1112901
+48 +102	0.2	Hg	colourless, prismatic	190	1112902
+98 +152	0.2	Hg	colourless, prismatic	190	1112903
+148 +202	0.2	Hg	colourless, prismatic	190	1112904
+198 +252	0.2	Hg	colourless, prismatic	190	1112905*
+248 +302	0.2	Hg	colourless, prismatic	190	1112906*
+298 +360	0.2	Hg	colourless, prismatic	190	1112907*
Complete set					1112908*
Complete set with case					1112909*
Case for 7 instruments					202301

\* no official certification possible

### Additional Order No.

- ...../01 Officially calibrated without certificate
- ...../02 Officially calibrated with certificate
- ...../03 With works certificate
- ...../04 With DAkkS calibration certificate
- ...../50 Capillary: blue reflecting, prismatic
- ...../80 "Safety coating" (PTFE coated up to 200 °C)

# Precision thermometer sets acc. to Anschütz

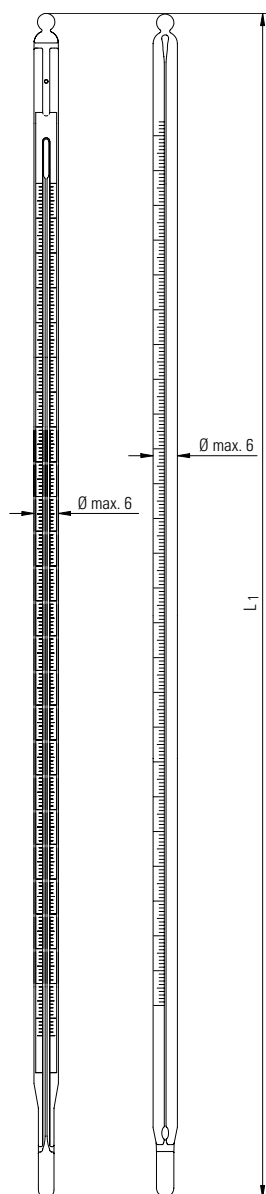

Precision thermometer set acc. to Anschütz

Consisting of 7 instruments from -10 up to +360 °C

## Enclosed type

Scale units: 0.1 °C

Ø max. 6 mm, immersion: total, suitable for official certification

Temperature range °C	Scale °C	Filling	Capillary form	Total length L <sub>1</sub> mm	Ref. No.
-10 +52	0.1	Hg	colourless, prismatic	340	1122101
+48 +102	0.1	Hg	colourless, prismatic	340	1122102
+98 +152	0.1	Hg	colourless, prismatic	340	1122103*
+148 +202	0.1	Hg	colourless, prismatic	340	1122104*
+198 +252	0.1	Hg	colourless, prismatic	340	1122105*
+248 +302	0.1	Hg	colourless, prismatic	340	1122106*
+298 +360	0.1	Hg	colourless, prismatic	340	1122107*
Complete set					1122108*
Complete set with case					1122109*
Case for 7 instruments					202101

\* no official certification possible

Precision thermometer set acc. to Anschütz

Consisting of 7 instruments from -10 up to +360 °C

## Stem type

Ø max. 6 mm, immersion: total, suitable for official certification

Temperature range °C	Scale °C	Filling	Capillary form	Total length L <sub>1</sub> mm	Ref. No.
-10 +52	0.1	Hg	yellow back, round	340	1122201
+48 +102	0.1	Hg	yellow back, round	340	1122202
+98 +152	0.1	Hg	yellow back, round	340	1122203*
+148 +202	0.1	Hg	yellow back, round	340	1122204*
+198 +252	0.1	Hg	yellow back, round	340	1122205*
+248 +302	0.1	Hg	yellow back, round	340	1122206*
+298 +360	0.1	Hg	yellow back, round	340	1122207*
Complete set					1122208*
Complete set with case					1122209*
Case for 7 instruments					202101

\* no official certification possible

## Additional Order No.

- ...../01 Officially calibrated without certificate
- ...../02 Officially calibrated with certificate
- ...../03 With works certificate
- ...../04 With DAkkS calibration certificate
- ...../50 Capillary: blue reflecting, prismatic
- ...../80 "Safety coating" (PTFE coated up to 200 °C)

# Precision thermometer sets acc. to Kahlbaum

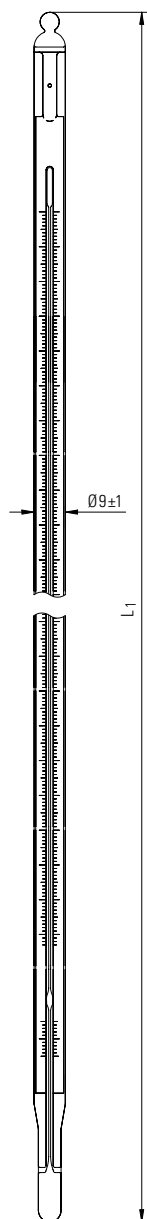

Precision thermometer set acc. to Anschütz

Consisting of 7 instruments from -10 up to +360 °C

### Enclosed type

Ø 9 ±1 mm, immersion: total, suitable for official certification

Temperature range °C	Scale °C	Auxiliary scale °C	Filling	Capillary form	Total length L <sub>1</sub> mm	Ref. No.
-10 +50	0.1	+100	Hg	colourless, round	440	1122701
+50 +100	0.1	0	Hg	colourless, round	440	1122702
+100 +150	0.1	0	Hg	colourless, round	440	1122703*
+150 +200	0.1	0 and +100	Hg	colourless, round	440	1122704*
+200 +250	0.1	0 and +100	Hg	colourless, round	440	1122705*
+250 +300	0.1	0 and +100	Hg	colourless, round	440	1122706*
+300 +360	0.1	0 and +100	Hg	colourless, round	440	1122707*
Complete set						1122708*
Complete set with case						1122709*
Case for 7 instruments						201501

\* no official certification possible

### Additional Order No.

- ...../01 Officially calibrated without certificate
- ...../02 Officially calibrated with certificate
- ...../03 With works certificate
- ...../04 With DAkkS calibration certificate
- ...../50 Capillary: blue reflecting, prismatic
- ...../80 "Safety coating" (PTFE coated up to 200 °C)

# Metal protection cases for laboratory thermometers

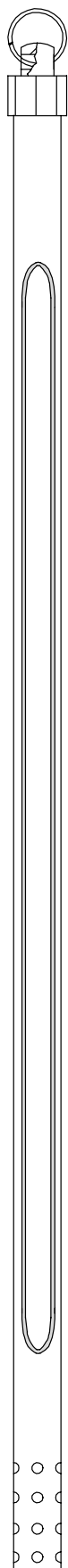

Metal protection cases for laboratory thermometers

Materials: brass (usable up to 250 °C) or  
stainless steel (for temperatures > 250 °C)

Outer diameter: 12 mm

Screw cap with ring

For thermometer length mm	Total length of casing mm	Material	Ref. No.
200	225	Brass	7710001
220	245	Brass	7718010
250	275	Brass	7711002
280	305	Brass	7718011
300	325	Brass	7712003
320	345	Brass	7718012
340	365	Brass	7713004
360	385	Brass	7718013
380	405	Brass	7714005
400	425	Brass	7715006
420	445	Brass	7718014
450	475	Brass	7716007
480	505	Brass	7717008
500	525	Brass	7718015
550	575	Brass	7718009
200	225	Stainless steel	7730001
220	245	Stainless steel	7738010
250	275	Stainless steel	7731002
280	305	Stainless steel	7738011
300	325	Stainless steel	7732003
320	345	Stainless steel	7738012
340	365	Stainless steel	7733004
360	385	Stainless steel	7738013
380	405	Stainless steel	7734005
400	425	Stainless steel	7735006
420	445	Stainless steel	7738014
450	475	Stainless steel	7736007
480	505	Stainless steel	7737008
500	525	Stainless steel	7738015
550	575	Stainless steel	7738009

# *Ice point and boiling point precision thermometers*

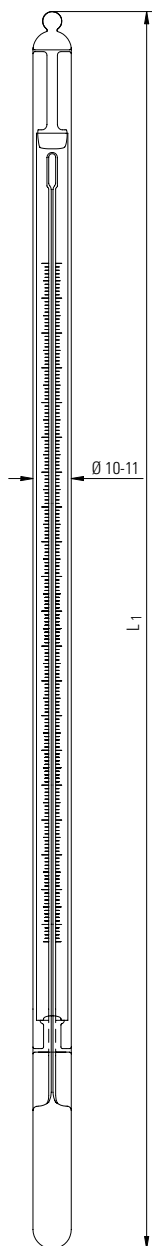

Ice point precision thermometers

## **High-precision instruments**

Enclosed type

Ø 10-11 mm, immersion: total, suitable for official certification

Temperature range °C	Scale °C	Filling	Capillary form	Total length L <sub>1</sub> mm	Ref. No.
-1 +1	0.01	Hg	colourless, round	350	1112701
-1.5 +1.5	0.01	Hg	colourless, round	350	1112702

Boiling point precision thermometers

## **High-precision instruments**

Enclosed type

Ø 10-11 mm, immersion: total, suitable for official certification

Temperature range °C	Scale °C	Filling	Capillary form	Total length L <sub>1</sub> mm	Ref. No.
+98 +101	0.01	Hg	colourless, round	380	1112601
+95 +105	0.02	Hg	colourless, round	380	1112602

### **Additional Order No.**

- ...../01 Officially calibrated without certificate
- ...../02 Officially calibrated with certificate
- ...../03 With works certificate
- ...../04 With DAkkS calibration certificate



# High-precision standard thermometers

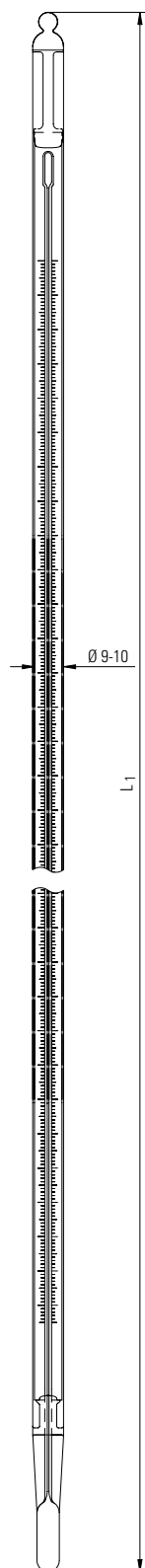

High-precision standard thermometers

## High-precision instruments

Enclosed type

Ø 9-10 mm, immersion: total, suitable for official certification

Temperature range °C	Scale °C	Auxiliary scale °C	Filling	Capillary form	Total length L <sub>1</sub> mm	Ref. No.
-58 -30	0.1	0	Hg-Tl	colourless, round	360	1102501
-38 +10	0.1	—	Hg	colourless, round	400	1102502
-38 +30	0.1	—	Hg	colourless, round	450	1102503
-10 +10	0.1	—	Hg	colourless, round	300	1102505
-25 +25	0.1	—	Hg	colourless, round	420	1102506
-5 +102	0.1	—	Hg	colourless, round	600	1102507
+95 +152	0.1	—	Hg	colourless, round	470	1102508*
+145 +202	0.1	—	Hg	colourless, round	470	1102509*
+195 +252	0.1	—	Hg	colourless, round	470	1102510*
+245 +302	0.1	—	Hg	colourless, round	470	1102511*
+295 +352	0.1	—	Hg	colourless, round	470	1102512*

\* no official certification possible

### Additional Order No.

- ...../01 Officially calibrated without certificate
- ...../02 Officially calibrated with certificate
- ...../03 With works certificate
- ...../04 With DAkkS calibration certificate

# High-precision standard thermometer sets

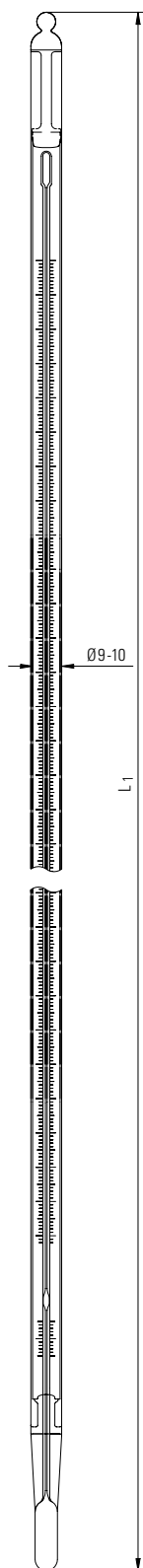

High-precision standard thermometer set

**Consisting of 8 high-precision instruments from -38 up to +302 °C**

Enclosed type, Ø 9-10 mm, immersion: total, suitable for official certification

Temperature range °C	Scale °C	Auxiliary scale °C	Filling	Capillary form	Total length L <sub>1</sub> mm	Ref. No.
-38 +10	0.1	100	Hg	colourless, round	480	1112001
-5 +34	0.1	100	Hg	colourless, round	480	1112002
+33 +67	0.1	0 and 100	Hg	colourless, round	480	1112003
+66 +102	0.1	0	Hg	colourless, round	480	1112004
+95 +152	0.1	0	Hg	colourless, round	480	1112005*
+145 +202	0.1	0	Hg	colourless, round	480	1112006*
+195 +252	0.1	0	Hg	colourless, round	480	1112007*
+245 +302	0.1	0	Hg	colourless, round	480	1112008*
Complete set						1112009*
Complete set with case						1112010*
Case for 8 instruments						203001

\* no official certification possible

High-precision standard thermometer set

**Consisting of 5 high-precision instruments from -1 up to +100 °C**

Enclosed type, Ø 11-12 mm, immersion: total, suitable for official certification

Temperature range °C	Scale °C	Auxiliary scale °C	Filling	Capillary form	Total length L <sub>1</sub> mm	Ref. No.
-1 +20	0.02	—	Hg	colourless, round	630	1112201
+19 +40	0.02	0	Hg	colourless, round	630	1112202
+39 +60	0.02	0	Hg	colourless, round	630	1112203
+59 +80	0.02	0	Hg	colourless, round	630	1112204
+79 +100	0.02	0	Hg	colourless, round	630	1112205
Complete set						1112206
Complete set with case						1112207
Case for 5 instruments						203201

High-precision standard thermometer set

**Consisting of 5 high-precision instruments from -25 up to +102 °C**

Enclosed type, Ø 9-10 mm, immersion: total, suitable for official certification

Temperature range °C	Scale °C	Auxiliary Scale °C	Filling	Capillary form	Total length L <sub>1</sub> mm	Ref. No.
-25 +1	0.05	—	Hg	colourless, round	450	1112101
-1 +26	0.05	—	Hg	colourless, round	450	1112102
+24 +51	0.05	0	Hg	colourless, round	450	1112103
+49 +76	0.05	0	Hg	colourless, round	450	1112104
+74 +102	0.05	0	Hg	colourless, round	450	1112105
Complete set						1112106
Complete set with case						1112107
Case for 5 instruments						203101

# High-precision standard thermometer sets

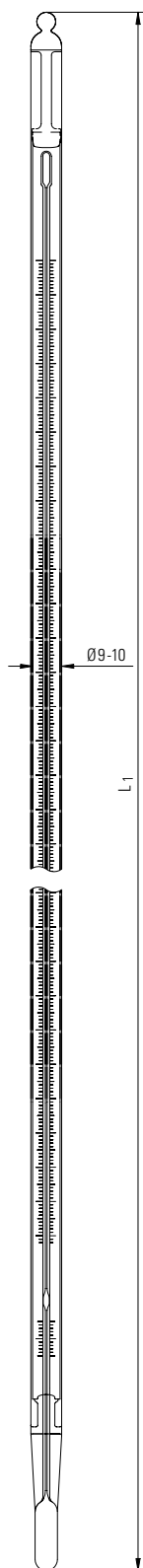

High-precision standard thermometer set

**Consisting of 11 high-precision instruments from -58 up to +105 °C**

Enclosed type, Ø 9-10 mm, immersion: total, suitable for official certification

Temperature range °C	Scale °C	Auxiliary scale °C	Filling	Capillary form	Total length L <sub>1</sub> mm	Ref. No.
-58 -44	0.02	0	Hg-Tl	colourless, round	580	1112301
-45 -30	0.02	0	Hg-Tl	colourless, round	580	1112302
-30 -15	0.02	0	Hg	colourless, round	580	1112303
-15 +1	0.02	—	Hg	colourless, round	580	1112304
-1 +15	0.02	—	Hg	colourless, round	580	1112305
+15 +30	0.02	0	Hg	colourless, round	580	1112306
+30 +45	0.02	0	Hg	colourless, round	580	1112307
+45 +60	0.02	0	Hg	colourless, round	580	1112308
+60 +75	0.02	0	Hg	colourless, round	580	1112309
+75 +90	0.02	0	Hg	colourless, round	580	1112310
+90 +105	0.02	0	Hg	colourless, round	580	1112311
Complete set						1112312
Complete set with case						1112313
Case for 11 instruments						203301

High-precision standard thermometer set

**Consisting of 11 high-precision instruments from -5 up to +50 °C**

Enclosed type, Ø 9-10 mm, immersion: total, suitable for official certification

Temperature range °C	Scale °C	Auxiliary scale °C	Filling	Capillary form	Total length L <sub>1</sub> mm	Ref. No.
-5 +1	0.01	—	Hg	colourless, round	420	1112501
-1 +5	0.01	—	Hg	colourless, round	420	1112502
+5 +10	0.01	0	Hg	colourless, round	420	1112503
+10 +15	0.01	0	Hg	colourless, round	420	1112504
+15 +20	0.01	0	Hg	colourless, round	420	1112505
+20 +25	0.01	0	Hg	colourless, round	420	1112506
+25 +30	0.01	0	Hg	colourless, round	420	1112507
+30 +35	0.01	0	Hg	colourless, round	420	1112508
+35 +40	0.01	0	Hg	colourless, round	420	1112509
+40 +45	0.01	0	Hg	colourless, round	420	1112510
+45 +50	0.01	0	Hg	colourless, round	420	1112511
Complete set						1112512
Complete set with case						1112513
Case for 11 instruments						203501

#### Additional Order No.

- ...../01 Officially calibrated without certificate
- ...../02 Officially calibrated with certificate
- ...../03 With works certificate
- ...../04 With DAkkS calibration certificate

# Precision laboratory straight stem thermometers acc. to DIN 12781

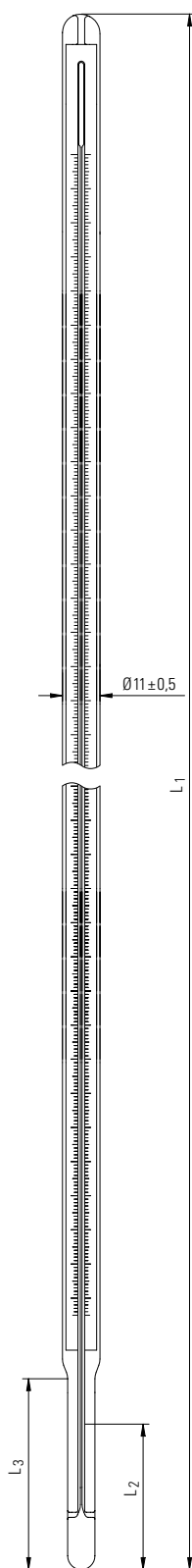

Precision laboratory straight stem thermometers acc. to DIN 12781

Enclosed type, upper part:  $\varnothing 11 \pm 0.5$  mm, lower part:  $\varnothing 8 \pm 0.5$  mm, suitable for official certification

Temp. range °C	Scale °C	Filling	Capillary form	Stem length $L_3$ mm	Immersion $L_2$ mm	Total length $L_1$ mm	Ref. No.
-100 +30	1	red	colourless, prismatic	50	30	300	1052701
-100 +30	1	red	colourless, prismatic	100	80	350	1052702
-100 +30	1	red	colourless, prismatic	150	130	400	1052703
-100 +30	1	red	colourless, prismatic	200	180	450	1052704
-100 +30	1	red	colourless, prismatic	250	230	500	1052705
-100 +30	1	red	colourless, prismatic	300	280	550	1052706
-100 +30	0.5	red	colourless, prismatic	50	30	370	1052801
-100 +30	0.5	red	colourless, prismatic	100	80	420	1052802
-100 +30	0.5	red	colourless, prismatic	200	180	520	1052804
-58 +30	0.1	Hg-TL	colourless, prismatic	50	30	550	1062401
-58 +30	0.1	Hg-TL	colourless, prismatic	100	80	600	1062402
-58 +30	0.1	Hg-TL	colourless, prismatic	150	130	650	1062403
-58 +30	0.1	Hg-TL	colourless, prismatic	200	180	700	1062404
-30 +50	1	red	colourless, prismatic	50	30	325	1062501
-30 +50	1	red	colourless, prismatic	100	80	375	1062502
-30 +50	1	red	colourless, prismatic	150	130	425	1062503
-30 +50	1	red	colourless, prismatic	200	180	475	1062504
-30 +50	1	red	colourless, prismatic	250	230	525	1062505
-30 +50	1	red	colourless, prismatic	300	280	575	1062506
-38 +50	0.1	Hg	colourless, prismatic	50	30	550	1072001
-38 +50	0.1	Hg	colourless, prismatic	100	80	600	1072002
-38 +50	0.1	Hg	colourless, prismatic	150	130	650	1072003
-38 +50	0.1	Hg	colourless, prismatic	200	180	700	1072004
-38 +50	0.1	Hg	colourless, prismatic	250	230	750	1072005
-38 +50	0.1	Hg	colourless, prismatic	300	280	800	1072006
-10 +50	1	Hg	colourless, prismatic	50	30	325	1072301
-10 +50	1	Hg	colourless, prismatic	100	80	375	1072302
-10 +50	0.1	Hg	colourless, prismatic	50	30	400	1072601
-10 +50	0.1	Hg	colourless, prismatic	100	80	450	1072602
-10 +50	0.1	Hg	colourless, prismatic	150	130	500	1072603
-10 +50	0.1	Hg	colourless, prismatic	200	180	550	1072604
-10 +50	0.1	Hg	colourless, prismatic	250	230	600	1072605
-10 +50	0.1	Hg	colourless, prismatic	300	280	650	1072606
-10 +100	1	Hg	colourless, prismatic	50	30	325	1072701
-10 +100	1	Hg	colourless, prismatic	100	80	375	1072702
-10 +100	1	Hg	colourless, prismatic	150	130	425	1072703
-10 +100	1	Hg	colourless, prismatic	200	180	475	1072704
-10 +100	1	Hg	colourless, prismatic	250	230	525	1072705
-10 +100	1	Hg	colourless, prismatic	300	280	575	1072706
-10 +100	1	blue	colourless, prismatic	50	30	325	1072707
-10 +100	1	blue	colourless, prismatic	100	80	375	1072708
-10 +100	1	blue	colourless, prismatic	150	130	425	1072709
-10 +100	1	blue	colourless, prismatic	200	180	475	1072710

# Precision laboratory straight stem thermometers acc. to DIN 12781

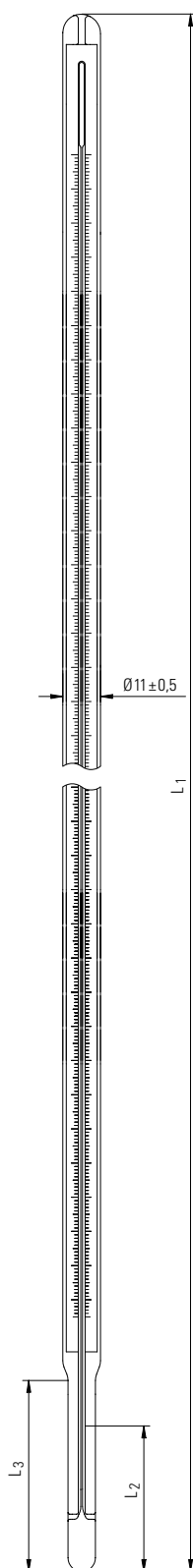

Precision laboratory straight stem thermometers acc. to DIN 12781

Enclosed type, upper part:  $\varnothing 11 \pm 0.5$  mm, lower part:  $\varnothing 8 \pm 0.5$  mm, suitable for official certification

Temp. range °C	Scale °C	Filling	Capillary form	Stem length $L_3$ mm	Immersion $L_2$ mm	Total length $L_1$ mm	Ref. No.
-10 +100	1	blue	colourless, prismatic	250	230	525	1072711
-10 +100	1	blue	colourless, prismatic	300	280	575	1072712
-10 +100	0.5	Hg	colourless, prismatic	50	30	325	1072801
-10 +100	0.5	Hg	colourless, prismatic	100	80	375	1072802
-10 +100	0.5	Hg	colourless, prismatic	150	130	425	1072803
-10 +100	0.5	Hg	colourless, prismatic	200	180	475	1072804
-10 +100	0.5	Hg	colourless, prismatic	250	230	525	1072805
-10 +100	0.5	Hg	colourless, prismatic	300	280	575	1072806
-10 +100	0.5	blue	colourless, prismatic	50	30	325	1072807
-10 +100	0.5	blue	colourless, prismatic	100	80	375	1072808
-10 +100	0.5	blue	colourless, prismatic	150	130	425	1072809
-10 +100	0.5	blue	colourless, prismatic	200	180	475	1072810
-10 +100	0.5	blue	colourless, prismatic	250	230	525	1072811
-10 +100	0.5	blue	colourless, prismatic	300	280	575	1072812
0 +100	0.1	Hg	colourless, prismatic	50	30	570	1082101
0 +100	0.1	Hg	colourless, prismatic	100	80	620	1082102
0 +100	0.1	Hg	colourless, prismatic	150	130	670	1082103
0 +100	0.1	Hg	colourless, prismatic	200	180	720	1082104
0 +100	0.1	Hg	colourless, prismatic	250	230	770	1082105
0 +100	0.1	Hg	colourless, prismatic	300	280	820	1082106
-20 +150	1	Hg	colourless, prismatic	50	30	325	1082201
-20 +150	1	Hg	colourless, prismatic	100	80	375	1082202
-20 +150	1	Hg	colourless, prismatic	150	130	425	1082203
-20 +150	1	Hg	colourless, prismatic	200	180	475	1082204
-20 +150	1	Hg	colourless, prismatic	250	230	525	1082205
-20 +150	1	Hg	colourless, prismatic	300	280	575	1082206
-20 +150	1	blue	colourless, prismatic	50	30	325	1082208
-20 +150	1	blue	colourless, prismatic	100	80	375	1082209
-20 +150	1	blue	colourless, prismatic	150	130	425	1082210
-20 +150	1	blue	colourless, prismatic	200	180	475	1082211
-20 +150	1	blue	colourless, prismatic	250	230	525	1082212
-20 +150	1	blue	colourless, prismatic	300	280	575	1082213
-20 +150	1	blue	colourless, prismatic	400	380	675	1082214

For these thermometers metal protection cases made of brass or stainless steel are available on request.

#### Additional Order No.

- ...../01 officially calibrated without certificate
- ...../02 officially calibrated with certificate
- ...../03 with works certificate
- ...../04 with DAkkS calibration certificate
- ...../50 Capillary: blue reflecting, prismatic

# Precision laboratory straight stem thermometers acc. to DIN 12781

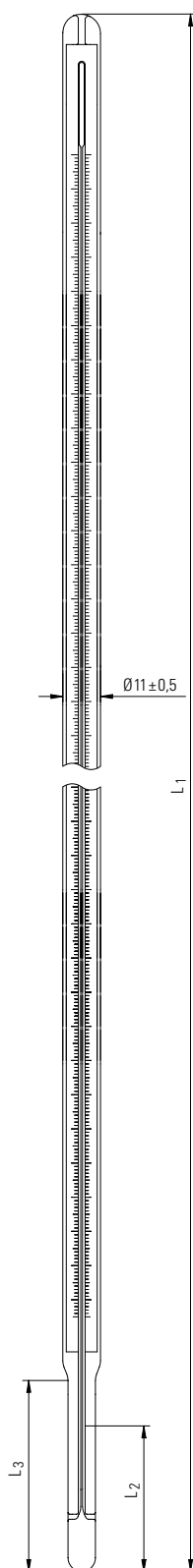

Precision laboratory straight stem thermometers acc. to DIN 12781

Enclosed type, upper part:  $\varnothing 11 \pm 0.5$  mm, lower part:  $\varnothing 8 \pm 0.5$  mm, suitable for official certification

Temp. range °C	Scale °C	Filling	Capillary form	Stem length $L_3$ mm	Immersion $L_2$ mm	Total length $L_1$ mm	Ref. No.
-20 +250	1	Hg	colourless, prismatic	50	30	325	1082801
-20 +250	1	Hg	colourless, prismatic	100	80	375	1082802
-20 +250	1	Hg	colourless, prismatic	150	130	425	1082803
-20 +250	1	Hg	colourless, prismatic	200	180	475	1082804
-20 +250	1	Hg	colourless, prismatic	250	230	525	1082805
-20 +250	1	Hg	colourless, prismatic	300	280	575	1082806
-20 +250	1	Hg	colourless, prismatic	400	380	675	1082807
-20 +250	1	blue	colourless, prismatic	50	30	325	1082808*
-20 +250	1	blue	colourless, prismatic	100	80	375	1082809*
-20 +250	1	blue	colourless, prismatic	150	130	425	1082810*
-20 +250	1	blue	colourless, prismatic	200	180	475	1082811*
-20 +250	1	blue	colourless, prismatic	250	230	525	1082812*
-20 +250	1	blue	colourless, prismatic	300	280	575	1082813*
-20 +250	1	blue	colourless, prismatic	400	380	675	1082814*
-20 +360	2	Hg	colourless, prismatic	50	30	325	1092001
-20 +360	2	Hg	colourless, prismatic	100	80	375	1092002
-20 +360	2	Hg	colourless, prismatic	150	130	425	1092003
-20 +360	2	Hg	colourless, prismatic	200	180	475	1092004
-20 +360	2	Hg	colourless, prismatic	250	230	525	1092005
-20 +360	2	Hg	colourless, prismatic	300	280	575	1092006
-20 +360	2	Hg	colourless, prismatic	400	380	675	1092007
+48 +102	0.1	Hg	colourless, prismatic	50	30	500	1072921
+48 +102	0.1	Hg	colourless, prismatic	100	80	550	1072922
+48 +102	0.1	Hg	colourless, prismatic	150	130	600	1072923
+48 +102	0.1	Hg	colourless, prismatic	200	180	650	1072924
+48 +102	0.1	Hg	colourless, prismatic	250	230	700	1072925
+48 +102	0.1	Hg	colourless, prismatic	300	280	750	1072926
+98 +152	0.1	Hg	colourless, prismatic	50	30	500	1072931*
+98 +152	0.1	Hg	colourless, prismatic	100	80	550	1072932*
+98 +152	0.1	Hg	colourless, prismatic	150	130	600	1072933*
+98 +152	0.1	Hg	colourless, prismatic	200	180	650	1072934*
+98 +152	0.1	Hg	colourless, prismatic	250	230	700	1072935*
+98 +152	0.1	Hg	colourless, prismatic	300	280	750	1072936*

\* no official certification possible

For these thermometers metal protection cases made of brass or stainless steel are available on request.

#### Additional Order No.

- ...../01 officially calibrated without certificate
- ...../02 officially calibrated with certificate
- ...../03 with works certificate
- ...../04 with DAkks calibration certificate
- ...../50 Capillary: blue reflecting, prismatic

# Precision laboratory straight stem thermometers acc. to DIN 12781

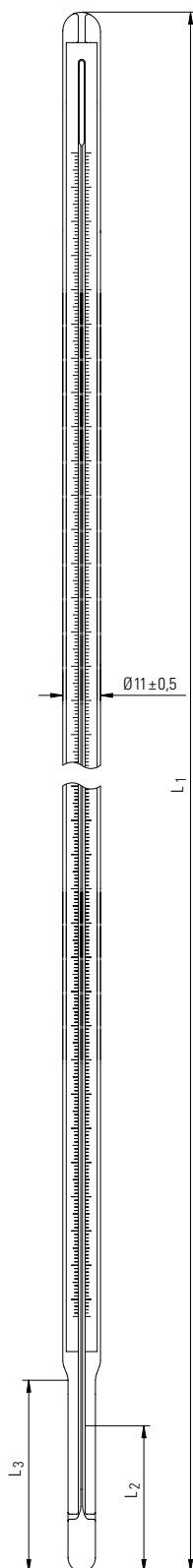

Precision laboratory straight stem thermometers acc. to DIN 12781

Enclosed type, upper part:  $\varnothing 11 \pm 0.5$  mm, lower part:  $\varnothing 8 \pm 0.5$  mm

Temp. range °C	Scale °C	Filling	Capillary form	Stem length $L_3$ mm	Immersion $L_2$ mm	Total length $L_1$ mm	Ref. No.
+148 +202	0.1	Hg	colourless, prismatic	50	30	500	1072941*
+148 +202	0.1	Hg	colourless, prismatic	100	80	550	1072942*
+148 +202	0.1	Hg	colourless, prismatic	150	130	600	1072943*
+148 +202	0.1	Hg	colourless, prismatic	200	180	650	1072944*
+148 +202	0.1	Hg	colourless, prismatic	250	230	700	1072945*
+148 +202	0.1	Hg	colourless, prismatic	300	280	750	1072946*
+198 +252	0.1	Hg	colourless, prismatic	50	50	500	1072951*
+198 +252	0.1	Hg	colourless, prismatic	100	80	550	1072952*
+198 +252	0.1	Hg	colourless, prismatic	150	130	600	1072953*
+198 +252	0.1	Hg	colourless, prismatic	200	180	650	1072954*
+198 +252	0.1	Hg	colourless, prismatic	250	230	700	1072955*
+198 +252	0.1	Hg	colourless, prismatic	300	280	750	1072956*
+248 +302	0.1	Hg	colourless, prismatic	50	50	500	1072961*
+248 +302	0.1	Hg	colourless, prismatic	100	80	550	1072962*
+248 +302	0.1	Hg	colourless, prismatic	150	130	600	1072963*
+248 +302	0.1	Hg	colourless, prismatic	200	180	650	1072964*
+248 +302	0.1	Hg	colourless, prismatic	250	230	700	1072965*
+248 +302	0.1	Hg	colourless, prismatic	300	280	750	1072966*
+298 +360	0.1	Hg	colourless, prismatic	50	50	500	1072971*
+298 +360	0.1	Hg	colourless, prismatic	100	80	550	1072972*
+298 +360	0.1	Hg	colourless, prismatic	150	130	600	1072973*
+298 +360	0.1	Hg	colourless, prismatic	200	180	650	1072974*
+298 +360	0.1	Hg	colourless, prismatic	250	230	700	1072975*
+298 +360	0.1	Hg	colourless, prismatic	300	280	750	1072976*

\* no official certification possible

For these thermometers metal protection cases made of brass or stainless steel are available on request.

## Additional Order No.

- ...../01 officially calibrated without certificate
- ...../02 officially calibrated with certificate
- ...../03 with works certificate
- ...../04 with DAkkS calibration certificate
- ...../50 Capillary: blue reflecting, prismatic

# Precision calorimeter thermo- meters acc. to DIN 12771

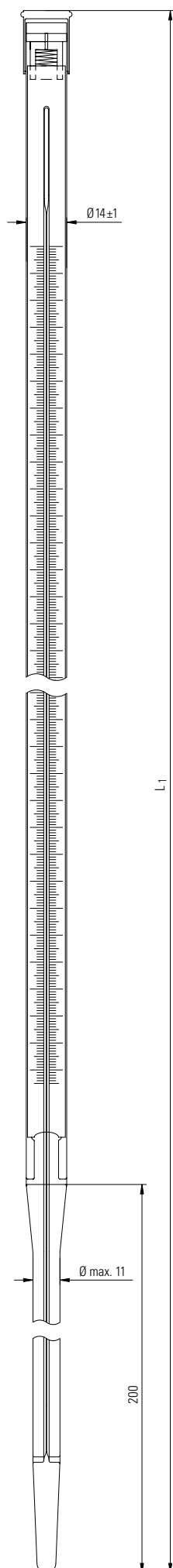

Precision calorimeter thermometers acc. to DIN 12771

## High-precision instruments

Upper part: 14-15 x 500 mm (with metal cap), lower part: max. 11 x 200 mm (= immersion)

Enclosed type, suitable for official certification

Type	Temperature range °C	Scale °C	Filling	Capillary form	Total length L <sub>1</sub> mm	Ref. No.
CALE15	+9 +15	0.01	Hg	colourless, round	700	1132601
CALE18	+12 +18	0.01	Hg	colourless, round	700	1132602
CALE21	+15 +21	0.01	Hg	colourless, round	700	1132603
CALE24	+18 +24	0.01	Hg	colourless, round	700	1132604
CALE27	+21 +27	0.01	Hg	colourless, round	700	1132605
CALE30	+24 +30	0.01	Hg	colourless, round	700	1132606
CALE33	+27 +33	0.01	Hg	colourless, round	700	1132607
CALE36	+30 +36	0.01	Hg	colourless, round	700	1132608
CALE39	+33 +39	0.01	Hg	colourless, round	700	1132609
CALE42	+36 +42	0.01	Hg	colourless, round	700	1132610
CALE45	+39 +45	0.01	Hg	colourless, round	700	1132611
Complete set						1132612
Complete set with case						1132613
Case for 11 instruments						202501

## Additional Order No.

- ...../01 Officially calibrated without certificate
- ...../02 Officially calibrated with certificate
- ...../03 With works certificate
- ...../04 With DAkkS calibration certificate



# Precision calorimeter thermo- meters with auxiliary scale

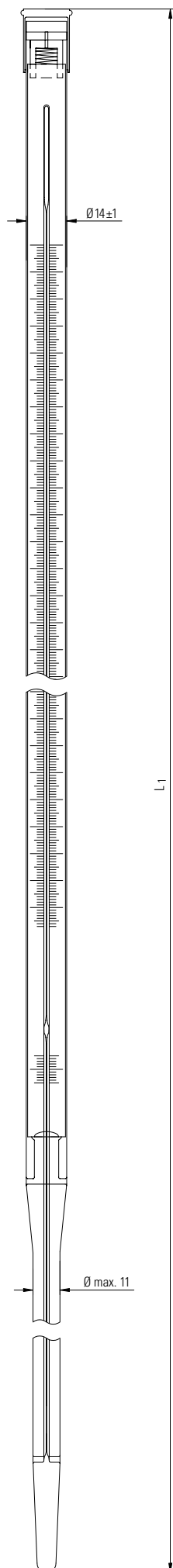

Precision calorimeter thermometers with auxiliary scale at °C

## High-precision instruments

Immersion: total

Enclosed type, suitable for official certification

Temperature range °C	Scale °C	Auxiliary scale °C	Filling	Capillary form	Total length L <sub>1</sub> mm	Ref. No.
+9 +15	0.01	0	Hg	colourless, round	700	1132701
+12 +18	0.01	0	Hg	colourless, round	700	1132702
+15 +21	0.01	0	Hg	colourless, round	700	1132703
+18 +24	0.01	0	Hg	colourless, round	700	1132704
+21 +27	0.01	0	Hg	colourless, round	700	1132705
+24 +30	0.01	0	Hg	colourless, round	700	1132706
+27 +33	0.01	0	Hg	colourless, round	700	1132707
+30 +36	0.01	0	Hg	colourless, round	700	1132708
+33 +39	0.01	0	Hg	colourless, round	700	1132709
+36 +42	0.01	0	Hg	colourless, round	700	1132710
+39 +45	0.01	0	Hg	colourless, round	700	1132711
Complete set						1132712
Complete set with case						1132713
Case for 11 instruments						202601

## Additional Order No.

- ...../01 Officially calibrated without certificate
- ...../02 Officially calibrated with certificate
- ...../03 With works certificate
- ...../04 With DAkkS calibration certificate

# Precision calorimeter thermo- meters acc. to Berthelot-Mahler

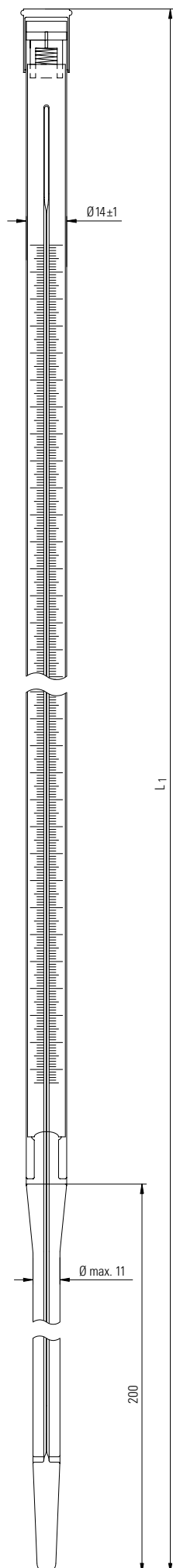

Precision calorimeter thermometers acc. to Berthelot-Mahler

## High-precision instruments

Upper part:  $\varnothing$  14-15 x 580 mm (with metal cap), lower part:  $\varnothing$  max. 11 x 200 mm (= immersion)

**Enclosed type**, suitable for official certification

Temperature range °C	Scale °C	Filling	Capillary form	Total length $L_1$ mm	Ref. No.
-10 +0	0.01	Hg	colourless, round	780	1132801
-5 +5	0.01	Hg	colourless, round	780	1132802
0 +10	0.01	Hg	colourless, round	780	1132803
+10 +20	0.01	Hg	colourless, round	780	1132804
+15 +25	0.01	Hg	colourless, round	780	1132805
+20 +30	0.01	Hg	colourless, round	780	1132806
+25 +35	0.01	Hg	colourless, round	780	1132807
+30 +40	0.01	Hg	colourless, round	780	1132808
+35 +45	0.01	Hg	colourless, round	780	1132809
+40 +50	0.01	Hg	colourless, round	780	1132810
+45 +55	0.01	Hg	colourless, round	780	1132811
+50 +60	0.01	Hg	colourless, round	780	1132812
+55 +65	0.01	Hg	colourless, round	780	1132813
+60 +70	0.01	Hg	colourless, round	780	1132814
+65 +75	0.01	Hg	colourless, round	780	1132815
+70 +80	0.01	Hg	colourless, round	780	1132816
+80 +90	0.01	Hg	colourless, round	780	1132817
+90 +100	0.01	Hg	colourless, round	780	1132818
+95 +105	0.01	Hg	colourless, round	780	1132819*
+100 +110	0.01	Hg	colourless, round	780	1132820*
Complete set					1132841
Complete set with 2 cases					1132842
Case for 10 instruments					203551

\* no official certification possible

Temperature range °C	Scale °C	Filling	Capillary form	Total length $L_1$ mm	Ref. No.
0 +20	0.02	Hg	colourless, round	780	1132821
+20 +40	0.02	Hg	colourless, round	780	1132822
+40 +60	0.02	Hg	colourless, round	780	1132823
+60 +80	0.02	Hg	colourless, round	780	1132824
+80 +100	0.02	Hg	colourless, round	780	1132825
Complete set					1132831
Complete set with case					1132832
Case for 5 instruments					203651

## Additional Order No.

- ...../01 Officially calibrated without certificate
- ...../02 Officially calibrated with certificate
- ...../03 With works certificate
- ...../04 With DAkkS calibration certificate

# Precision calorimeter thermo- meters acc. to ISO 651/BS 791

Precision calorimeter thermometers acc. to ISO 651 / BS 791

## High-precision instruments

Ø 9-10 mm, immersion: total

**Stem type**, suitable for official certification

Type	Temperature range °C	Scale °C	Filling	Capillary form	Total length L <sub>1</sub> mm	Ref. No.
STCal/0.01/15	+9 +15	0.01	Hg	yellow back, round	760	1132901
STCal/0.01/18	+12 +18	0.01	Hg	yellow back, round	760	1132902
STCal./0.01/21	+15 +21	0.01	Hg	yellow back, round	760	1132903
STCal./0.01/24	+18 +24	0.01	Hg	yellow back, round	760	1132904
STCal./0.01/27	+21 +27	0.01	Hg	yellow back, round	760	1132905
STCal./0.01/30	+24 +30	0.01	Hg	yellow back, round	760	1132906
STCal./0.01/33	+27 +33	0.01	Hg	yellow back, round	760	1132907
STCal./0.01/36	+30 +36	0.01	Hg	yellow back, round	760	1132908
STCal./0.01/39	+33 +39	0.01	Hg	yellow back, round	760	1132909
STCal./0.01/42	+36 +42	0.01	Hg	yellow back, round	760	1132910
STCal./0.01/45	+39 +45	0.01	Hg	yellow back, round	760	1132911
Complete set						1132912
Complete set with case						1132913
Case for 11 instruments						202801

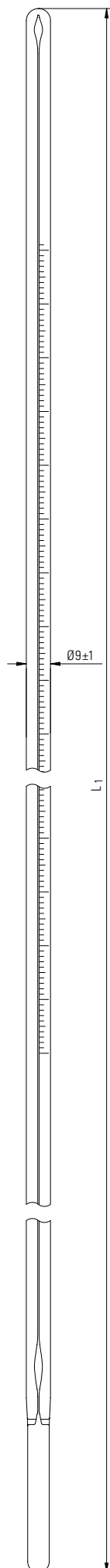

## Additional Order No.

- ...../01 Officially calibrated without certificate
- ...../02 Officially calibrated with certificate
- ...../03 With works certificate
- ...../04 With DAkkS calibration certificate

# Precision adjusting thermo- meters acc. to Beckmann

Precision adjusting thermometers acc. to Beckmann

## High-precision instruments

With dropping trap and auxiliary scale

Upper part:  $\varnothing$  14-15 x 430 mm (with metal cap), lower part:  $\varnothing$  max. 11 x 200 mm (= immersion)

### DIN 12789/ASTM 115CU for boiling point method

Temp. range °C	Scale °C	Adjusting scale °C	Filling	Capillary form	Immersion $L_2$ mm	Total length $L_1$ mm	Ref. No.
6	0.01	-20 +160	Hg	colourless, round	200	630	1132102
10	0.02	-20 +160	Hg	colourless, round	200	630	1132103
1	0.002	-20 +160	Hg	colourless, round	200	630	1132104

### DIN 12789/ASTM 115CD for ice point method

Temp. range °C	Scale °C	Adjusting scale °C	Filling	Capillary form	Immersion $L_2$ mm	Total length $L_1$ mm	Ref. No.
6	0.01	-20 +160	Hg	colourless, round	200	630	1132201
10	0.02	-20 +160	Hg	colourless, round	200	630	1132202
1	0.002	-20 +160	Hg	colourless, round	200	630	1132203

Precision adjusting thermometers acc. to Beckmann

## High-precision instruments

With dropping trap and auxiliary scale

### With ground joint NS 19/26

Upper part:  $\varnothing$  14-15 x 430 mm (with metal cap), lower part:  $\varnothing$  max. 11 x 170 mm (= immersion 170 mm)

### With ground joint NS 19/26 for boiling method

Temp. range °C	Scale °C	Adjusting scale °C	Filling	Capillary form	Immersion $L_2$ mm	Total length $L_1$ mm	Ref. No.
6	0.01	-20 +160	Hg	colourless, round	170	630	1132402

### With ground joint NS 19/26 for ice point method

Temp. range °C	Scale °C	Adjusting scale °C	Filling	Capillary form	Immersion $L_2$ mm	Total length $L_1$ mm	Ref. No.
6	0.01	-20 +160	Hg	colourless, round	170	630	1132406

### Additional Order No.

- ...../01 Officially calibrated without certificate
- ...../02 Officially calibrated with certificate
- ...../03 With works certificate
- ...../04 With DAkkS calibration certificate

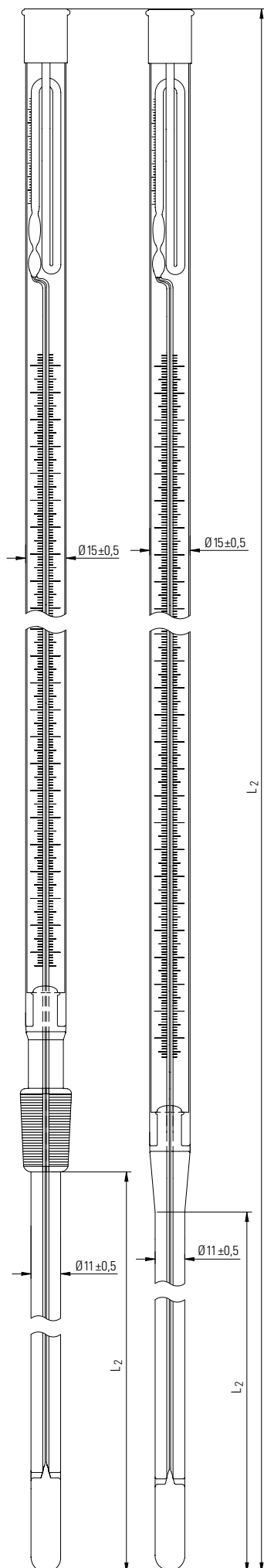

# Magnifying glasses for high-precision thermometers

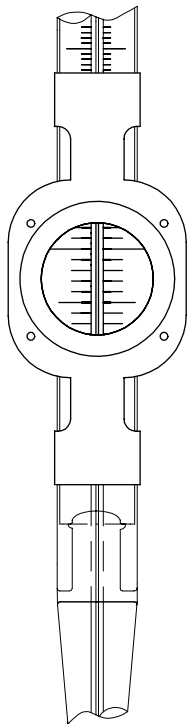

Magnifying glasses for high-precision thermometers  
4-fold magnification

For thermometer Ø mm	Ref. No.
14-18	200101
5-7	200101/6
8-11	200101/8

## Remote monitoring system OPTI-MESS 2000



Standard camera set consisting of:  
camera, connection cable 3 m, 9" monitor, power supply and  
coaxial plug Composite Video 1.0 Vp-p

Remote monitoring system	Ref. No.
OPTI-MESS 2000 Complete set	2000 100

Optional accessories:	Ref. No.
Connection cable 10 m	2000 500
Connection cable 20 m	2000 501
Monitor with 4x selector switch, integrated	2000 700
Monitor with 4x selector switch, separate	2000 700-1
Monitor swing arm for table fixture	2000 710

# Precision ground joint thermometers acc. to DIN 12784

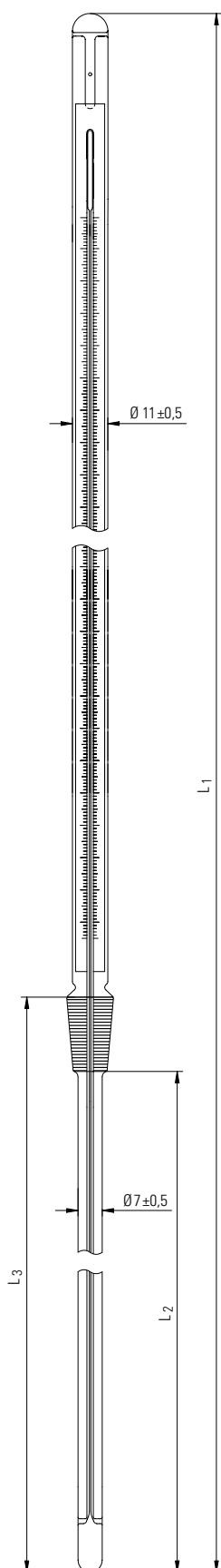

Precision ground joint thermometers acc. to DIN 12784

Enclosed type, upper part:  $\varnothing 11 \pm 0.5$  mm, with ground joint NS 14.5/23, suitable for official certification

Temp. range °C	Scale °C	Filling	Capillary form	Stem length $L_3$ mm	Immersion $L_2$ mm	Total length $L_1$ mm	Ref. No.
-100 +30	1	red	colourless, prismatic	68	45	318	1292201
-100 +30	1	red	colourless, prismatic	75	52	325	1292202
-100 +30	1	red	colourless, prismatic	95	72	345	1292203
-100 +30	1	red	colourless, prismatic	125	102	375	1292204
-100 +30	0.5	red	colourless, prismatic	68	45	318	1292301
-100 +30	0.5	red	colourless, prismatic	75	52	325	1292302
-100 +30	0.5	red	colourless, prismatic	95	72	345	1292303
-100 +30	0.5	red	colourless, prismatic	125	102	375	1292304
-38 +50	1	Hg	blue reflecting, prismatic	68	45	318	1292601
-38 +50	1	Hg	blue reflecting, prismatic	75	52	325	1292602
-38 +50	1	Hg	blue reflecting, prismatic	95	72	345	1292603
-38 +50	1	Hg	blue reflecting, prismatic	125	102	375	1292604
-38 +50	1	Hg	blue reflecting, prismatic	150	127	400	1292605
-38 +50	1	Hg	blue reflecting, prismatic	175	152	425	1292606
-38 +50	1	Hg	blue reflecting, prismatic	200	177	450	1292607
-38 +50	1	Hg	blue reflecting, prismatic	250	227	500	1292608
-38 +50	1	Hg	blue reflecting, prismatic	300	277	550	1292609
-38 +50	1	blue	colourless, prismatic	68	45	318	1292610
-38 +50	1	blue	colourless, prismatic	75	52	325	1292611
-38 +50	1	blue	colourless, prismatic	95	72	345	1292612
-38 +50	1	blue	colourless, prismatic	125	102	375	1292613
-38 +50	1	blue	colourless, prismatic	150	127	400	1292614
-38 +50	1	blue	colourless, prismatic	175	152	425	1292615
-38 +50	1	blue	colourless, prismatic	200	177	450	1292616
-10 +100	1	Hg	blue reflecting, prismatic	68	45	318	1302001
-10 +100	1	Hg	blue reflecting, prismatic	75	52	325	1302002
-10 +100	1	Hg	blue reflecting, prismatic	95	72	345	1302003
-10 +100	1	Hg	blue reflecting, prismatic	125	102	375	1302004
-10 +100	1	Hg	blue reflecting, prismatic	150	127	400	1302005
-10 +100	1	Hg	blue reflecting, prismatic	175	152	425	1302006
-10 +100	1	Hg	blue reflecting, prismatic	200	177	450	1302007
-10 +100	1	Hg	blue reflecting, prismatic	250	227	500	1302008
-10 +100	1	Hg	blue reflecting, prismatic	300	277	550	1302009
-10 +100	0.5	Hg	blue reflecting, prismatic	68	45	418	1302101
-10 +100	0.5	Hg	blue reflecting, prismatic	75	52	425	1302102
-10 +100	0.5	Hg	blue reflecting, prismatic	95	72	445	1302103
-10 +100	0.5	Hg	blue reflecting, prismatic	125	102	475	1302104
-10 +100	0.5	Hg	blue reflecting, prismatic	150	127	500	1302105
-10 +100	0.5	Hg	blue reflecting, prismatic	175	152	525	1302106
-10 +100	0.5	Hg	blue reflecting, prismatic	200	177	550	1302107
-10 +100	0.5	Hg	blue reflecting, prismatic	250	227	600	1302108
-10 +100	0.5	Hg	blue reflecting, prismatic	300	277	650	1302109

# Precision ground joint thermometers acc. to DIN 12784

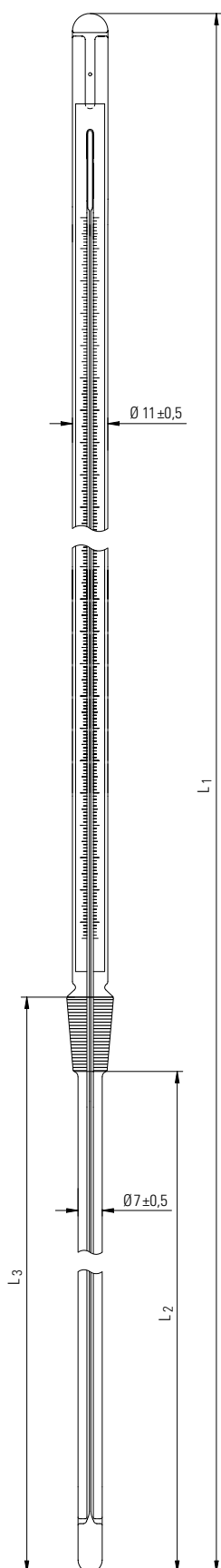

Precision ground joint thermometers acc. to DIN 12784

Enclosed type, upper part:  $\varnothing 11 \pm 0.5$  mm, with ground joint NS 14.5/23, suitable for official certification

Temp. range °C	Scale °C	Filling	Capillary form	Stem length $L_3$ mm	Immersion $L_2$ mm	Total length $L_1$ mm	Ref. No.
-10 +150	1	Hg	blue reflecting, prismatic	68	45	318	1302201
-10 +150	1	Hg	blue reflecting, prismatic	75	52	325	1302202
-10 +150	1	Hg	blue reflecting, prismatic	95	72	345	1302203
-10 +150	1	Hg	blue reflecting, prismatic	125	102	375	1302204
-10 +150	1	Hg	blue reflecting, prismatic	150	127	400	1302205
-10 +150	1	Hg	blue reflecting, prismatic	175	152	425	1302206
-10 +150	1	Hg	blue reflecting, prismatic	200	177	450	1302207
-10 +150	1	Hg	blue reflecting, prismatic	250	227	500	1302208
-10 +150	1	Hg	blue reflecting, prismatic	300	277	550	1302209
-10 +150	1	blue	colourless, prismatic	68	45	318	1302210
-10 +150	1	blue	colourless, prismatic	75	52	325	1302211
-10 +150	1	blue	colourless, prismatic	95	72	345	1302212
-10 +150	1	blue	colourless, prismatic	125	102	375	1302213
-10 +150	1	blue	colourless, prismatic	150	127	400	1302214
-10 +150	1	blue	colourless, prismatic	175	152	425	1302215
-10 +150	1	blue	colourless, prismatic	200	177	450	1302216
-10 +150	0.5	Hg	blue reflecting, prismatic	68	45	418	1302301
-10 +150	0.5	Hg	blue reflecting, prismatic	75	52	425	1302302
-10 +150	0.5	Hg	blue reflecting, prismatic	95	72	445	1302303
-10 +150	0.5	Hg	blue reflecting, prismatic	125	102	475	1302304
-10 +150	0.5	Hg	blue reflecting, prismatic	150	127	500	1302305
-10 +150	0.5	Hg	blue reflecting, prismatic	175	152	525	1302306
-10 +150	0.5	Hg	blue reflecting, prismatic	200	177	550	1302307
-10 +150	0.5	Hg	blue reflecting, prismatic	250	227	600	1302308
-10 +150	0.5	Hg	blue reflecting, prismatic	300	277	650	1302309
-10 +250	1	Hg	blue reflecting, prismatic	68	45	368	1302401
-10 +250	1	Hg	blue reflecting, prismatic	75	52	375	1302402
-10 +250	1	Hg	blue reflecting, prismatic	95	72	395	1302403
-10 +250	1	Hg	blue reflecting, prismatic	125	102	425	1302404
-10 +250	1	Hg	blue reflecting, prismatic	150	127	450	1302405
-10 +250	1	Hg	blue reflecting, prismatic	175	152	475	1302406
-10 +250	1	Hg	blue reflecting, prismatic	200	177	500	1302407
-10 +250	1	Hg	blue reflecting, prismatic	250	227	550	1302408
-10 +250	1	Hg	blue reflecting, prismatic	300	277	600	1302409

Further ground joint sizes see next page.

#### Additional Order No.

- ...../01 Officially calibrated without certificate
- ...../02 Officially calibrated with certificate
- ...../03 With works certificate
- ...../04 With DAkkS calibration certificate

# Precision ground joint thermometers acc. to DIN 12784

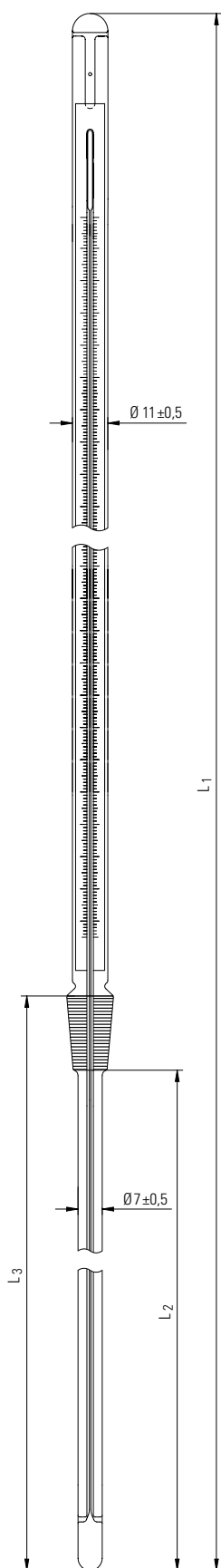

Precision ground joint thermometers acc. to DIN 12784

Enclosed type, upper part:  $\varnothing 11 \pm 0.5$  mm, with ground joint NS 14.5/23, suitable for official certification

Temp. range °C	Scale °C	Filling	Capillary form	Stem length $L_3$ mm	Immersion $L_2$ mm	Total length $L_1$ mm	Ref. No.
-10 +250	1	blue	colourless, prismatic	68	45	368	1302410*
-10 +250	1	blue	colourless, prismatic	75	52	375	1302411*
-10 +250	1	blue	colourless, prismatic	95	72	395	1302412*
-10 +250	1	blue	colourless, prismatic	125	102	425	1302413*
-10 +250	1	blue	colourless, prismatic	150	127	450	1302414*
-10 +250	1	blue	colourless, prismatic	175	152	475	1302415*
-10 +250	1	blue	colourless, prismatic	200	177	500	1302416*
-10 +250	0.5	Hg	blue reflecting, prismatic	68	45	418	1302501
-10 +250	0.5	Hg	blue reflecting, prismatic	75	52	425	1302502
-10 +250	0.5	Hg	blue reflecting, prismatic	95	72	445	1302503
-10 +250	0.5	Hg	blue reflecting, prismatic	125	102	475	1302504
-10 +250	0.5	Hg	blue reflecting, prismatic	150	127	500	1302505
-10 +250	0.5	Hg	blue reflecting, prismatic	175	152	525	1302506
-10 +250	0.5	Hg	blue reflecting, prismatic	200	177	550	1302507
-10 +250	0.5	Hg	blue reflecting, prismatic	250	227	600	1302508
-10 +250	0.5	Hg	blue reflecting, prismatic	300	277	650	1302509
-10 +360	1	Hg	blue reflecting, prismatic	68	45	418	1302601
-10 +360	1	Hg	blue reflecting, prismatic	75	52	425	1302602
-10 +360	1	Hg	blue reflecting, prismatic	95	72	445	1302603
-10 +360	1	Hg	blue reflecting, prismatic	125	102	475	1302604
-10 +360	1	Hg	blue reflecting, prismatic	150	127	500	1302605
-10 +360	1	Hg	blue reflecting, prismatic	175	152	525	1302606
-10 +360	1	Hg	blue reflecting, prismatic	200	177	550	1302607
-10 +360	1	Hg	blue reflecting, prismatic	250	227	600	1302608
-10 +360	1	Hg	blue reflecting, prismatic	300	277	650	1302609

\* no official certification possible

## Further ground joint sizes

for the ground joint thermometers on pages 30-32

Ground joint size	Additional Order No.
NS 10/19	...../200
NS 12/21	...../201
NS 19/26	...../202
NS 29/32	...../203

## Additional Order No.

- ...../01 officially calibrated without certificate
- ...../02 officially calibrated with certificate
- ...../03 with works certificate
- ...../04 with DAkkS calibration certificate



# Precision ground joint thermometers

## Precision ground joint thermometers

Stem type,  $\varnothing 6 \pm 1$  mm, with ground joint NS 10/30, suitable for official certification

Temp. range °C	Scale °C	Filling	Capillary form	Stem length $L_3$ mm	Immersion $L_2$ mm	Total length $L_1$ mm	Ref. No.
-10 +150	1	Hg	yellow back, round	105	75	305	1322001
-10 +150	0.5	Hg	yellow back, round	105	75	405	1322002
-10 +250	1	Hg	yellow back, round	105	75	355	1322003
-10 +360	1	Hg	yellow back, round	105	75	405	1322004
-10 +150	1	Hg	yellow back, round	180	150	380	1322005
-10 +150	0.5	Hg	yellow back, round	180	150	480	1322006
-10 +250	1	Hg	yellow back, round	180	150	430	1322007
-10 +360	1	Hg	yellow back, round	180	150	480	1322008
-10 +150	1	Hg	yellow back, round	245	215	445	1322009
-10 +150	0.5	Hg	yellow back, round	245	215	545	1322010
-10 +250	1	Hg	yellow back, round	245	215	495	1322011
-10 +360	1	Hg	yellow back, round	245	215	545	1322012

With red or blue organic filling (up to +250 °C ) or with ground joint NS 10 available on request.

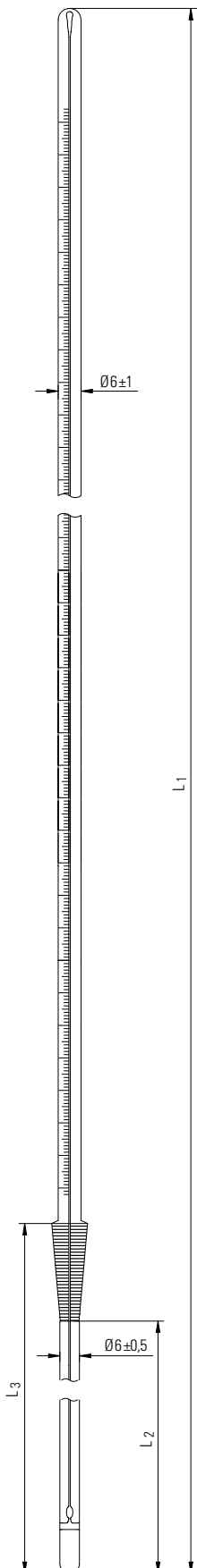

### Additional Order No.

- ...../01 officially calibrated without certificate
- ...../02 officially calibrated with certificate
- ...../03 with works certificate
- ...../04 with DAkkS calibration certificate

# Thermometers for Pyknometers acc. to DIN 12809

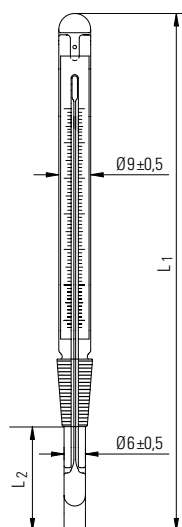

Thermometers for Pyknometers acc. to DIN 12809

Enclosed type, with ground joint NS 10/19, capillary: colourless, prismatic, immersion: total

Suitable for official certification

Temperature range °C	Scale °C	Filling	Length of lower part L <sub>2</sub> mm	For content ml	Total length L <sub>1</sub> mm	Ref. No.
+10 +35	0.2	Hg	20	10	115	1322104
+10 +40	0.2	Hg	20	10	115	1322105
0 +50	0.5	Hg	20	10	115	1322106
+10 +35	0.2	Hg	30	25	125	1322107
+10 +40	0.2	Hg	30	25	125	1322108
0 +50	0.5	Hg	30	25	125	1322109
+10 +35	0.2	Hg	35	50	135	1322110
+10 +40	0.2	Hg	35	50	135	1322111
0 +50	0.5	Hg	35	50	135	1322112

#### Additional Order No.

- ...../01 Officially calibrated without certificate
- ...../02 Officially calibrated with certificate
- ...../03 With works certificate
- ...../04 With DAkkS calibration certificate
- ...../50 Capillary: blue reflecting, prismatic

# Precision thermometers for adjustable ground joints

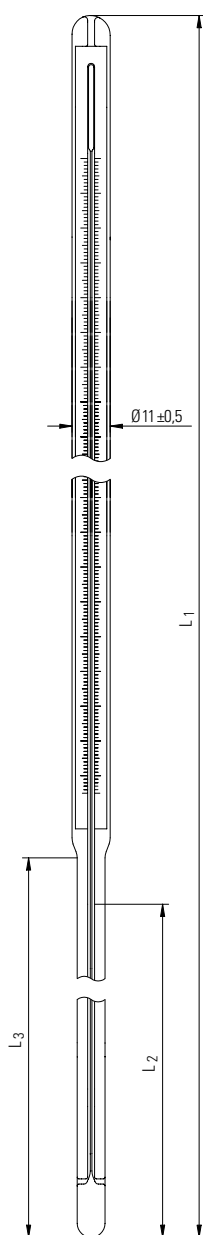

Precision thermometers for adjustable ground joints  
 Enclosed type, upper part:  $\varnothing 11 \pm 0.5$  mm, lower part:  $\varnothing 8 \pm 0.5$  mm

Temp. range °C	Scale °C	Filling	Capillary form	Stem length L <sub>3</sub> mm	Immersion L <sub>2</sub> mm	Total length L <sub>1</sub> mm	Ref. No.
-10 +50	1	Hg	colourless, prismatic	200	180	475	1072304-06
-10 +50	0.5	Hg	colourless, prismatic	200	180	475	1072404-06
-10 +50	1	Hg	colourless, prismatic	250	230	525	1072305-06
-10 +50	0.5	Hg	colourless, prismatic	250	230	525	1072405-06
-10 +50	1	Hg	colourless, prismatic	300	280	575	1072306-06
-10 +50	0.5	Hg	colourless, prismatic	300	280	575	1072406-06
-10 +100	1	Hg	colourless, prismatic	200	180	475	1072704-06
-10 +100	0.5	Hg	colourless, prismatic	200	180	475	1072804-06
-10 +100	1	Hg	colourless, prismatic	250	230	525	1072705-06
-10 +100	0.5	Hg	colourless, prismatic	250	230	525	1072805-06
-10 +100	1	Hg	colourless, prismatic	300	280	575	1072706-06
-10 +100	0.5	Hg	colourless, prismatic	300	280	575	1072806-06
-20 +150	1	Hg	colourless, prismatic	200	180	475	1082204-06
-10 +150	0.5	Hg	colourless, prismatic	200	180	520	1082304-06
-20 +150	1	Hg	colourless, prismatic	250	230	525	1082205-06
-10 +150	0.5	Hg	colourless, prismatic	250	230	570	1082305-06
-20 +150	1	Hg	colourless, prismatic	300	280	575	1082206-06
-10 +150	0.5	Hg	colourless, prismatic	300	280	620	1082306-06
-20 +250	1	Hg	colourless, prismatic	200	180	475	1082804-06
-20 +250	1	Hg	colourless, prismatic	250	230	525	1082805-06
-20 +250	1	Hg	colourless, prismatic	300	280	575	1082806-06
-10 +360	1	Hg	colourless, prismatic	200	180	500	1322222-06
-10 +360	1	Hg	colourless, prismatic	250	230	550	1322223-06
-10 +360	1	Hg	colourless, prismatic	300	280	600	1322224-06

Precise temperature measurements with adjustable ground joints are only possible by using a faden correction certificate, these certificates will be delivered together with every thermometer shown above.

## Adjustable ground joints for precision thermometers

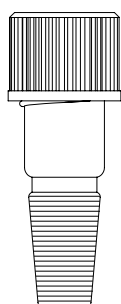

Adjustable ground joints for precision thermometers  
 Ground joint: Pyrex glass, cap: plastic material, gasket: silicone, PTFE coated

Ground joint size	Ref. No.
14/23	209811
19/26	209812
29/32	209814

# Technical information

## Filling liquids

### Thermometer filling liquids

Technical data of thermometric fillings

Thermometric fillings are divided into two groups, **wetting and non-wetting** liquids.

The excellent thermometric properties of mercury (including the fact that there is no ageing and no wetting of the glass surface as well as good expansion linearity over a wide temperature range) make mercury essential as an indicator liquid for precision thermometers and define the outstanding serviceability through precision and durability.

The table below gives an overview of the main filling liquids used together with their operating limits and their most common abbreviations. The upper and lower limits are defined by physical properties such as melting point and boiling point.

### Technical data of thermometric fillings

Filling liquids	Abbreviation	Lower limit °C	Upper limit °C	Characteristics
Mercury	Hg	-38.5	+800	non-wetting
Mercury thallium alloy	Hg-Tl	-58	approx. +150	non-wetting
Gallium alloy	Ga	0	approx. +1200	non-wetting
Technical pentane	C <sub>5</sub> H <sub>12</sub>	-200	approx. +35	wetting
Ethanol	C <sub>2</sub> H <sub>6</sub> O	-110	approx. +100	wetting
Pentanol	C <sub>5</sub> H <sub>12</sub> O	-115	approx. +135	wetting
Toluene	C <sub>7</sub> H <sub>8</sub>	-90	approx. +100	wetting
Creosote	—	approx. -40	approx. +210	wetting
Petroleum	C <sub>5</sub> H <sub>12</sub>	approx. -45	approx. +160	wetting
i-amyl benzoate	C <sub>12</sub> H <sub>16</sub> O <sub>2</sub>	approx. -40	approx. +220	wetting

# Technical information

## Filling liquids

### Thermometers with wetting liquid

Instructions for thermometers with separated indicator liquid

For many types of thermometer, the use of wetting thermometric liquids is essential. Different liquids are used according to the properties of the thermometer and their purpose (see technical data on thermometric liquids).

The following instructions only apply to procedures for thermometers filled with wetting liquids.

1. Before using these thermometers with wetting liquid, check whether any indicator liquid has separated off into the top of the capillary. Unlike the coloured indicator liquid, the separated liquid is generally colourless and can easily be overlooked.
2. All types of thermometer which are filled with wetting liquid have an expansion chamber at the top end of the capillary. By heating the temperature probe carefully, the indicator liquid can be coaxed up into this expansion chamber and combined again with the separated liquid. If necessary, it can be assisted in this by using a powerful centrifuge with the temperature probe pointing downwards.
3. If there is still a small amount of liquid remaining at the end of the expansion chamber, this has to be flame-heated carefully at this point (cigarette lighter, Bunsen burner or spirit burner) in order to combine it with the separated liquid by repeatedly heating the temperature probe while holding the thermometer upright.

The possible evaporation of the indicator liquid in the capillary is a physically induced phenomenon which cannot always be avoided in the event of poor storage or if conditions are unfavourable. It is definitely not a manufacturing defect, however, and provided that it is handled properly it will also not affect the guaranteed precision of the thermometer type used.

### Instructions on reuniting separated indicator columns

Handling after shipping damage (separated indicator columns)

Rough or incorrect handling in transport may cause the thermometric indicator liquid in the capillary opening to separate. The same effect can be caused by similar circumstances or by incorrect storage and improper use. **A production fault is therefore not involved. This is purely a physically induced phenomenon.**

In most cases, columns can be reunited by the users themselves. If the following advice is not successful, the problem can only be rectified by the manufacturer. A separated and reunited indicator column does not affect the guaranteed precision of the thermometer types used.

1. Most thermometers have an expansion chamber at the top. If the thermometer's measurement range does not exceed 300 °C, the separated indicator column can be reunited by simply coaxing the mercury up by warming it with a flame. After the indicator column has been reunited, the instrument is left to cool down and it is ensured that the entire indicator liquid returns from the expansion chamber into the capillary opening. If the first attempt has been unsuccessful, we recommend repeating the procedure several times.
2. In the case of very wide capillary openings, separated indicator columns can also be reunited by powerful centrifuging as with a clinical thermometer, whereby the temperature probe must point downwards.
3. As another alternative method, we recommend undercooling the temperature probe using a salt-ice mixture or dry ice (CO<sub>2</sub>) if available. The temperature probe is cooled down until all separated parts reunite in the indicator capillary and all entrained gases are above the indicator liquid. Particular attention must be paid to ensure that, when the thermometer warms up and the temperature increases, it is held upright in order to allow the indicator liquid to go up into the indicator capillary without any entrained gases. Particular care must be taken when checking whether there are any entrained gases remaining in the probe. If this is the case, however, the process must be repeated.

# Technical information

## Deviation limits

### Standardized tolerances acc. to EO 14-1

According to the German standard "Eichordnung EO 14-1" the following deviation limits for the most usual thermometers are specified:

Deviation limits for thermometers with **wetting** thermometric fillings (immersion: total):

Temperature range	Calibration tolerance at scale unit			
	0.5 °C	1 °C	2 °C	5 °C
from -200 °C up to -110 °C	—	±3 °C	±4 °C	±5 °C
above -110 °C up to -10 °C	±1 °C	±2 °C	±4 °C	±5 °C
above -10 °C up to +110 °C	±1 °C	±2 °C	±3 °C	±5 °C
above +110 °C up to +210 °C	—	±3 °C	±4 °C	±5 °C

Deviation limits for thermometers with **non-wetting** thermometric fillings (immersion: total):

Temperature range	Calibration tolerance at scale unit						
	0.05 °C	0.1 °C	0.2 °C	0.5 °C	1 °C	2 °C	5 °C
from -58 °C up to -10 °C	—	±0.3 °C	±0.4 °C	±0.5 °C	±1 °C	±2 °C	±5 °C
above -10 °C up to +110 °C	±0.1 °C	±0.2 °C	±0.3 °C	±0.5 °C	±1 °C	±2 °C	±5 °C
above +110 °C up to +210 °C	—	—	±0.4 °C	±0.5 °C	±1 °C	±2 °C	±5 °C
above +210 °C up to +410 °C	—	—	—	±1 °C	±2 °C	±2 °C	±5 °C
above +410 °C up to +610 °C	—	—	—	—	±3 °C	±4 °C	±5 °C
above +610 °C	—	—	—	—	—	±10 °C	±10 °C



# Product summary

- Catalogue **Engine Thermometers**
- Catalogue **General Purpose and Special Thermometers, Contact Thermometers**
- Catalogue **Precision Laboratory Thermometers & Sets, Ground Joint Thermometers**
- Catalogue **Meteorological Thermometers and Digital Measuring Devices**
- Catalogue **Precision Thermometers for Material Testing**
- Catalogue **Precision Hydrometers and Refractometers**
- Catalogue **Digital Measuring Devices**
- Catalogue **Resistance Thermometers and Thermocouples**

**Ludwig Schneider** 

**Ludwig Schneider GmbH & Co. KG**

Postfach 1561 · 97865 Wertheim

Am Eichamt 4 · 97877 Wertheim

Tel.: +49-93 42-8560-0 · Fax: +49-93 42-8 46 71

e-Mail: [info@ludwig-schneider.de](mailto:info@ludwig-schneider.de)

[www.ludwig-schneider.com](http://www.ludwig-schneider.com)